

ANNUAL REPORT 2011

Research for a More Sustainable
and Prosperous New Zealand

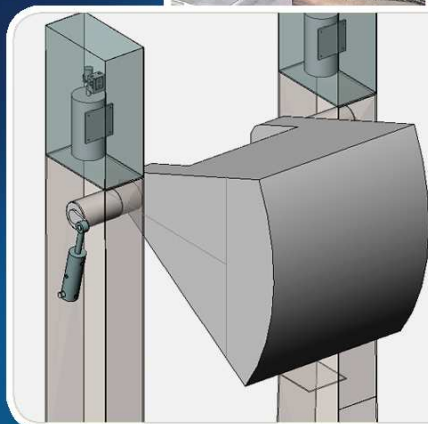
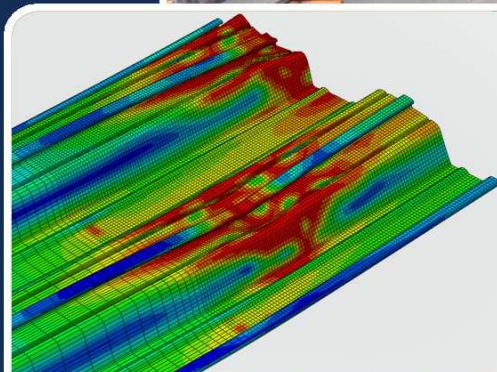
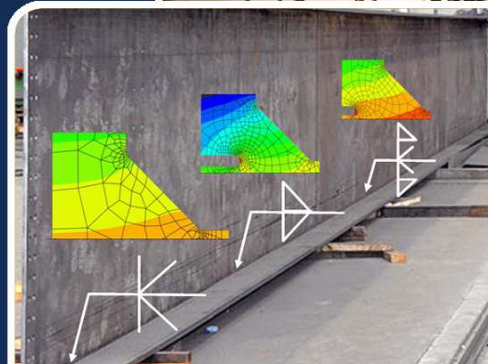
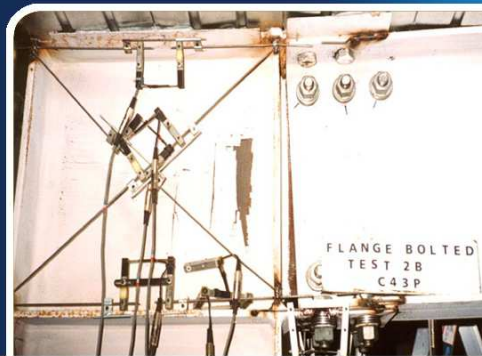

HERA

Innovation in Metals

Heavy Engineering Research Association

Who is HERA?

HERA is the Research Association for the New Zealand metals engineering industry. Established in 1979 under the Heavy Engineering Research Levy Act of 1978 as a member-based, not-for-profit Research Association, HERA today serves over 600 industry members as their leading resource support centre.

The HERA Executive for the Year 2010/2011 consists of:



Jacob Bonisch



Alistair Fussell



Tony Kerr

Front row from left:

Noel Davies (Past Chairman)
Dr Wolfgang Scholz
Scott Fuller
John Frear (Deputy Chairman)
Peter Herbert

Company Affiliation

Hydraulink Fluid Connectors
HERA
NZ Steel
OneSteel
SC Technik

Membership Representation

Heavy Engineering Educational & Research Foundation
Director
President NZ Steel
Ordinary & Associate Members
Manufacturers & Exporters Association (MEA)

Back row from left:

Sean Gledhill
Prof Thomas Neitzert
Peter Hutton (Chairman)
Terry Duff
David Moore (Past Chairman)
Mike Lehan

AURECON
Auckland University of Technology
Fitzroy Engineering
Southern Cross Engineering
Grayson Engineering
Page & Macrea

Co-opted representing Consultants
Co-opted representing Research Providers
Ordinary & Associate Members
Ordinary & Associate Members
Ordinary & Associate Members
Ordinary & Associate Members

Inset:

Jacob Bonisch
Alistair Fussell
Tony Kerr

Tenix New Zealand
SCNZ
Manukau Institute of Technology

Ordinary & Associate Members
Co-opted representing Steel Construction Industry
Ordinary & Associate Members

For the Joint Message from the HERA Chairman and HERA Director



About the Cover – Research for a More Sustainable and Prosperous New Zealand:

HERA research and its application by members are ensuring a more sustainable New Zealand. Examples shown from top are:

- Low-damage seismic structural steel systems: HERA research today is implemented in every modern NZ high rise steel structure
- Fatigue design details of welded joints heavily influence fabrication cost: HERA research indicates savings in welding cost of up 70% are possible
- HERA research in composite steel decking

solutions provides improvements in static, seismic, fire and vibration performance, and leads to successful exports of NZ decking products

- HERA research into the corrosion performance of lower-cost stainless steels provides confidence to realise significant material cost-savings
- HERA is driving significant capability development in renewable marine energy. This example is from WET-NZ's half-scale wave energy device built by Stark Brothers in Lyttelton

What does HERA do?

HERA MISSION

To be the catalyst for research, innovation, growth and development in New Zealand's Metals Engineering Industry

HERA KEY STRATEGIES

In fulfilling its mission, HERA applies seven key strategies:

KEY STRATEGY 1

To work with industry and its stakeholders to encourage and foster business innovation and growth

Page 5

KEY STRATEGY 2

To drive the development of technology, systems and products

Page 7

KEY STRATEGY 3

To assist in the provision of quality workforce required for ongoing industry development

Page 10

KEY STRATEGY 4

To develop and implement tools required for monitoring and enhancing industry growth and competitiveness

Page 12

KEY STRATEGY 5

To improve the HERA organisation by enhancing services and improving cost/benefit ratio

Page 13

KEY STRATEGY 6

To maintain and strengthen top class research and industry training capabilities

Page 14

KEY STRATEGY 7

To work towards a more sustainable Metals Engineering industry

Page 15

INDUSTRY VISION

The HERA Vision is to have New Zealand's Metals Engineering Industry achieve world-class standards for profitability, quality and sustainability

Other items covered in this Report:

Audited HERA Financial Report

Page 16

Heavy Engineering Educational and Research Foundation Report

Page 18

HERA Member Register

Page 19

HERA Divisions and Staff

Page 22



P. C. Hutton

Peter Hutton
HERA Chairman

Welcome to this Annual Review of HERA-related activities

2010/2011 HERA Year in Review:

- 13% growth in annual heavy steel usage marks turning point for heavy engineering industry
- Cost of steel stays largely unchanged leading to a competitive industry offering
- Positive heavy engineering export trend keeps trade balance in check
- HERA Strategy Review with focus on industry profitability completed
- Adjustment in HERA research focus towards increase in Clean Energy Technology research
- HERA 2010/2011 achievements demonstrate HERA value
- HERA's Financial Year: Better than budget forecast but funding remains uncertain
- One Voice Industry Advocacy: Metals New Zealand established at Industry Conference
- Outlook is for modest growth, an exciting research programme and challenging advocacy actions
- Tremendous industry support received in challenging year
- Thank you to all who assisted

Industry Activity on the Way Up

As shown in the long-term Heavy Steel Volume chart, 2010/11 heavy steel volumes used by the New Zealand industry increased by 12.6% to above 120,000 tonnes as compared to the previous year. This was an encouraging trend but still 20% below the peak years before the GFC (global financial crisis), where we saw over 150,000 tonnes of heavy steel being consumed.

No doubt, the infrastructure projects associated with the Government's response to the recession and the large projects around the Rugby World Cup contributed to this positive trend. However, it was not just construction which drove the upwards trend, heavy plate volumes associated more with the manufacturing sector grew by 13.3%.

Positive Heavy Engineering Export Trend Keeps Trade Balance in Check

The most outstanding statistic, however, is last year's export growth for our industry sector. As the 9-year graph from a selection of heavy engineering metals products below shows, last year's exports have grown by 25% to over \$0.4 Billion, more than remedying the previous year's drop of about 13%.

This is an excellent trend, especially considering the high rate of inflation and even more significantly, the strength of the NZ Dollar. It is a demonstration of the export strength of our high-value export industry. For the first time since 2005, we have balanced our trade in this heavy fabricated metals product collective.

Adjustment in HERA Research Focus

HERA's 2010 bid into the contestable Government research grants pool for co-funding of a cross-sector research programme for the development of export business opportunities was not successful.

However, a re-submission of the *Clean Energy Technology* component of the bid for the TechNZ co-funding pool was accepted, although with a much delayed start at the beginning of the next financial year. As a result, the income from Government programmes of typically around 30% was down to only 10% (see HERA Income Stream diagram).

This lack of bidding success had

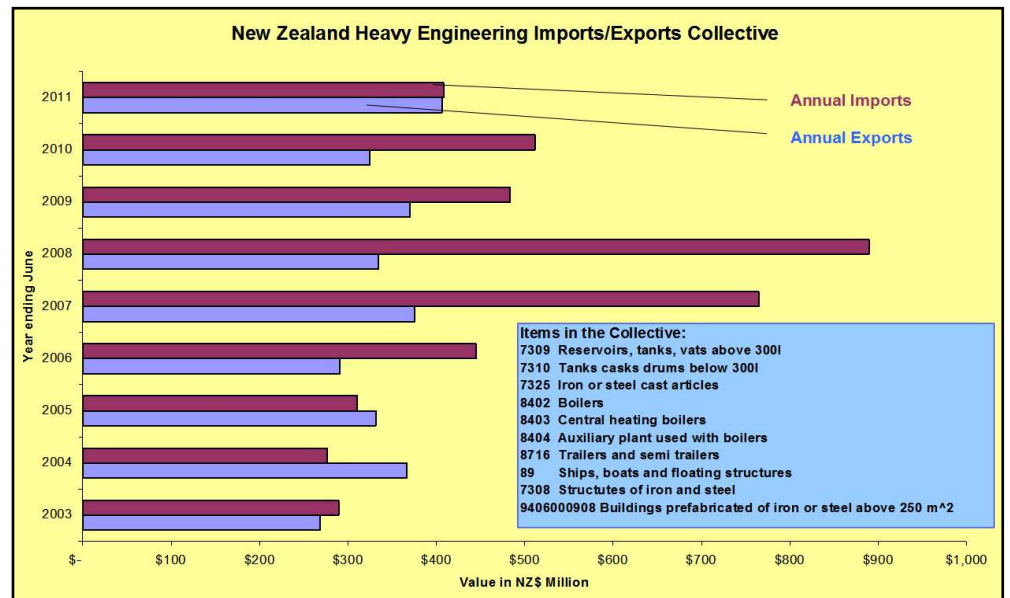

The cost of steel remained relatively constant over the year and this steel price stability, combined with the free capacity, led to a very competitive steel-based fabrication offering.

On the back of the GFC and the capacity surplus, however, many HERA members particularly those in the largely tender-based construction sector and those in steel construction, advised of very low profit margins during the year.

If we also consider the base metals products exported by NZ Steel and the NZ Aluminium Smelter, their exports grew by 19% to close to \$2.2 Billion, the collective exports of our metals-based industry sector contributed around 6% or \$2.6 Billion to New Zealand's total exports.

HERA Strategy Review with Focus on Industry Profitability

The perceived low levels of profits and increases in competing imports were two of the main items considered in this year's review of the HERA Strategy.

tragic implications, leading to the loss of two very experienced staff and shifting more focus to income generation at the expense of doing more common good industry research, e.g. for industry Standards development.

As result of the resource constraints, a draft seismic research programme - developed following the disastrous Canterbury earthquake and aimed at further improving options for damage-resisting steel framed systems and an associated seismic rating system - had to be shelved.

An industry survey covering the strategic framework, under which the industry and HERA operates, indicated a considerable gap in which the industry leaders would like to see their profitability and where it actually is.

There was consensus that the HERA approach of transforming industry from a low-profit contracting type business model to a high-value product/IP ownership model is the one to follow. As a result, the HERA strategy was modified with adjustments to HERA's industry development roadmap and research framework, but with reference to HERA's own business focus shifting towards a more commercial approach.

This change also marked a shift from the traditional dominance of steel construction-related research to a more balanced research effort encompassing the emerging heavy engineering-based clean energy and marine energy projects.

While in the year reported on, the Heavy Engineering Industry Development stream was capturing only 9% of the HERA resources spent (see HERA Expense Streams diagram). Next year, this will be more than doubled to about 20% of HERA expenses.

HERA 2010/2011 Achievements Demonstrate HERA Value Achievements from each of the HERA divisions are listed in

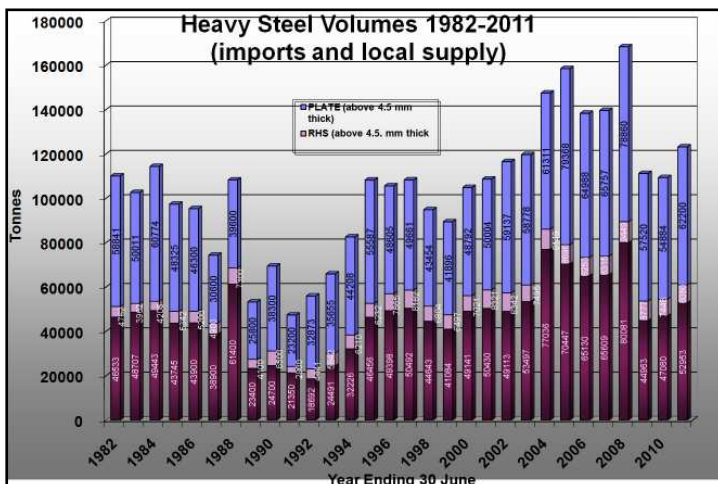

Source: Statistics New Zealand

detail under each of the Key Strategies. It is pleasing to note that in the February HERA Strategy Survey, 36% of HERA members responding believed that HERA provides adequate value for its levy investment, while 39% believe the return on investment is good. No one indicated that the return does not justify industry investment. The remainder of 24% surveyed felt they are unable to answer this question due to lack of information, an issue HERA will look at addressing.

HERA's Financial Year: Better than Budget Forecast but Funding Remains Uncertain

The HERA Executive had accepted a \$67k negative 2010/11 budget, with the deficit to be funded from reserves put in place should either industry funding via the levy be low or the loss of contestable Government funding occur, both of which happened this year. Also, the stop gap measure put in place to compensate until the requested HERA levy increase goes through Parliament, by way

Statutes Amendment Bill Process.

Although HERA has received assurances from all the main political parties that they are supporting the Amendment, higher priorities and the upcoming elections mean further delay for HERA. Therefore, it is unlikely that the industry-endorsed increase is happening before the 2012/13 financial year in time to bring stability to HERA's funding situation.

One Voice Industry Advocacy - Metals New Zealand Established at Industry Conference

Recognising the diverse and fragmented nature of the New Zealand metals engineering industry and support organisations, as well as the difficulty for HERA in fulfilling both roles of industry research and industry advocacy, Metals New Zealand was established to knit the 9 main industry organisations together and present a united industry. HERA provides the secretariat function for the new incorporated society. The Minister for Economic Development,

improving and especially for our consultant members who are very busy, indicating an expected increased flowthrough of work in the second half of the 2011/2012 year.

For HERA, the expectation is that steel volumes at least match this year's figures, and that the core levy funding is budgeted accordingly. However, as this funding is inadequate for the planned and desired HERA activities, HERA needs to increase self-generated income, tap into reserves for funding, and in co-operation with Government, continue its drive for the increase of the industry levy.

Through the promotion and application of the HERA industry development roadmap process, we expect to gain the increased co-operation of other organisations and agencies. The vision is to build on the transformation of our industry to product ownership in high-value niche markets, particularly in clean energy technology for local and export markets. Steel Construction research will focus on sustainability issues, new composite floor developments, the new *Composite Steel Bridge Design Guide* and the review of the NZS3404: *Steel Structures Standard*. The NZ Welding Centre's research focus will be on productivity, fatigue design and prediction of remaining life of welded joints affected by seismic action.

An additional advocacy item, the issue of the re-build of Christchurch, has been added to our main advocacy actions, which are the promotion of the benefits of local fabrication versus imports, the understanding and promotion of the sustainability of steel and metals in general, and lobbying Government support for the development of export-focused product development for our industry.

Steel-based construction offers major benefits for building cost-effective, damage-resistant and sustainable buildings and infrastructure. This also applies for buildings higher than the proposed 7-storey Christchurch central city building height limit. To ensure that those benefits flow through to the affected citizens and allow our industry to fully participate in the re-build, HERA in conjunction with SCNZ and its Metals NZ partners must communicate metals' benefits to planners and decision makers.

Thank You

2010/11 was a challenging year due to our resource constraints. To achieve our goals, HERA has drawn on many resources such as HERA Executive, members of the different HERA panels and committees, and also from outside organisations, including many Government departments who co-operated with us in a truly NZ Inc-type of approach.

Our thanks are due to all those who contributed, and this includes the staff of HERA who performed in an outstanding fashion. On this note, we would like to acknowledge with great sadness the unexpected passing of staff member Richard Green.

It is a pleasure working in such a co-operative environment, and we wish everyone success for the year ahead.



Wolfgang Scholz
Director

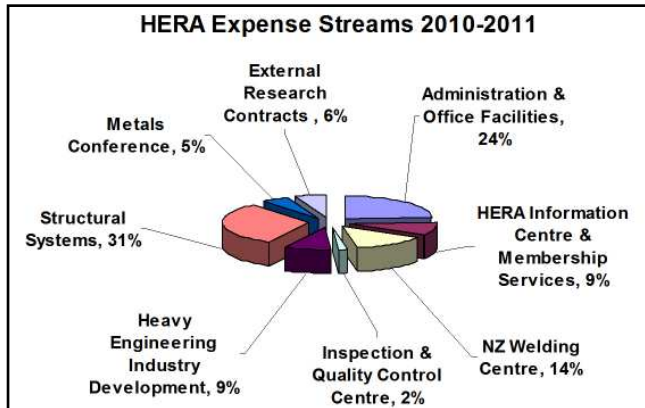
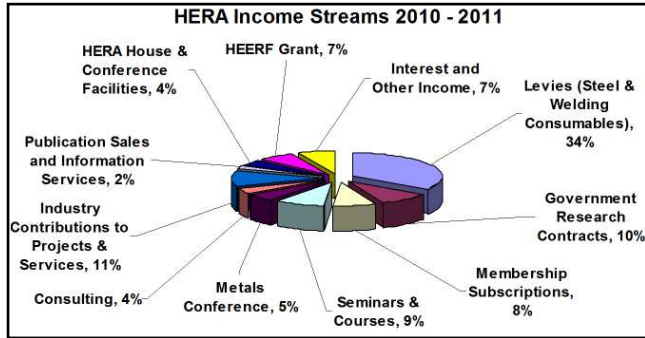

of the *Voluntary Tubular Section Levy* for heavy pipe used in steel construction, did not produce the predicted income due to low construction volumes.

However, better than budgeted levy income and a concerted effort by HERA staff to produce self-generated income reduced the deficit to only \$29k. While this year's result was considered pleasing, the outlook for balancing the HERA budget for next year is still difficult.

The Minister for Science and Innovation, Dr Wayne Mapp, while supportive of the Heavy Engineering Research Levy (HERL) Act Amendment, cited delays as a result of the Canterbury Earthquake as the reason to instead transfer the HERL Act Amendment being pursued, to the

development, the Hon David Carter, officially launched Metals NZ at the *Metals NZ Industry Conference* in April in Wellington. The Conference included the traditional *Industry Awards Gala Dinner* celebrating outstanding industry achievements.

The Executive accepts that, at least in the start up phase of Metals NZ, considerable HERA resources will be dedicated to industry advocacy, and that this will often come under the Metals NZ brand to leverage the greater common industry good. Having former HERA Chairman Noel Davies as the inaugural Metals NZ chairman provides vision, consistency and authority to our industry's cause.

Modest Growth Outlook, an Exciting Research Programme and Challenging Advocacy Actions
Overall business confidence is

2010/11 Success Stories
Here are some highlights (more details under Strategies):

- **Heavy Engineering Industry Development**
 - o Wins Tech NZ Research Project for low enthalpy heat-to-electrical energy conversion
 - o With AWATEA, writes proposal for New Zealand Marine Energy Ctr
 - o Geothermal Industry Capability Register revised
 - o Innovation research project undertaken incl report to NZTE
 - o HERA Industry Development Roadmap process recognised
- **Structural Systems Division**
 - o Publication of second edition of *New Zealand Steelwork Corrosion & Coatings Guide R4-133*
 - o Composite Bridge Design Guide draft launched with international bridge expert at national seminar series
 - o Thermal resistance of wall products evaluated using heat transfer analysis
 - o Sustainable Steel Council established & worked with ASI, Worldsteel & BCSCA
 - o Represented New Zealand on major European fire research programme
- **NZ Welding Centre**
 - o Conducted welding technology training courses and seminars
 - o Developed / published draft AS/NZS 1564.6 *Welding of Stainless Steels* Standard
 - o Completed Part 1 of *Performance of Alternative Grades of Stainless Steels*
 - o Completed *Fatigue Design & Fabrication Costs Bridge Girders*
 - o Developed *Assessment of Remaining Life of Steel Structures to Earthquake Loading*
 - o Published 5 papers & HERA Report R8-29 *Characterisation of New Zealand Welding Industry*
- **I & QC Centre**
 - o Maintained training & advisory programme with part-time commitment of former Manager Peter Hayward
- **HERA Information Centre (HIC)**
 - o Organised very successful Metals NZ Industry Conference
 - o Metals NZ web site established
 - o Refined membership database & online application process

KEY STRATEGY 1

To work with industry and its stakeholders to encourage and foster business innovation and growth

Metals NZ Industry Conference Links Research and Industry with the Market

HERA is the traditional force behind the organisation of the biennial *Metals New Zealand Industry Conference* (formerly Metals Industry Conference), which links research, industry development and Government interests. This year's Conference in April in Wellington, however, was different in that it was used as the vehicle to launch Metals New Zealand as a new sector-overarching body, providing a united voice to the metals-based industry of New Zealand. The Conference was a great demonstration of the importance of the metals engineering industry and showcased the industry as forward-looking.



The figures tell the story: An industry worth over \$7.3 Billion each year with around 30% of this in exports, accounting for approximately 6% share of NZ's exports. It is inspiring that New Zealand competes as a steel and aluminum supplier to the world, and that our exports are mainly in high-value niche manufacturing as diverse as super yachts and machinery, to steel frames for houses, to milking carousels, food processing technology, gas compressors, desalination plants, and drying kilns for timber.

Yet the metals industry's importance is little recognised as the industry is a quiet achiever, lacking a special advocacy voice. This lack of representation is mainly due to its very diverse nature across a wide range of sectors, and its association to other sectors such as food processing. Although of strategic importance and a strong GDP contributor, the industry is under-represented in terms of its share of R&D money, and the business development support it receives from Government and other entities.

Metals NZ intends to change the way the industry is viewed and treated, and the Metals NZ Industry Conference was the event that launched this mission. The Acting Minister for Economic Development, Hon David Carter, in his keynote address explicitly recognised that the industry is important and on the right track. Keynote addresses by Metals NZ Chairman Noel Davies, Hon Minister



The Acting Minister of Economic Development, David Carter, flanked by Metals NZ Chairman Noel Davies (left) and HERA Director Dr Wolfgang Scholz

Metals NZ Industry Conference Sponsors:



Metals NZ Industry Conference Partners:



David Carter, and others can be downloaded from the Conference section at www.metals.org.nz

The main focus of the Conference was to drive industry development and to achieve this by linking industry stakeholders, from manufacturers to R&D providers to representatives of target markets. All metals industry sector organisations participated and became Metals NZ organisation members: Steel Construction New Zealand (SCNZ), National Association of Steel Framed Housing (NASH), NZ Stainless Steel Development Association (NZSSDA), Lights Alloy Manufacturing Association (LAMNZ) and HERA. Each organised their own sessions under the theme of "Driving Productivity and Innovation".

Metals Industry Awards Gala Dinner Celebrates Industry Achievement

The metals engineering industry celebrated the achievements of individuals and companies that performed exceptional and noteworthy work at

the prestigious Metals NZ Industry Awards Gala Dinner held in the Ballroom of the Amora Hotel Wellington. During the course of the dinner, the following HERA Awards were presented:

Keith Smith Memorial Award for Distinguished Service to the NZ Metals Industry - Nick Calavrias



The winner of the Keith Smith Memorial Award for Distinguished Service to the Industry, Nick Calavrias, addresses the Conference

Exporter of the Year - A & G Price



Peter Yates (left) and Bill Lovell (right) from HERA member A&G Price with HERA Chairman Peter Hutton

Innovation Award Winner - Howick Engineering



From left: Bruce Coubray and Wayne Rowe from HERA member Howick Engineering with HERA Chairman Peter Hutton



The Metals NZ Industry Awards Gala Dinner was a rousing success thanks in part to the excellent showmanship of the MC Jim Hopkins and the generous support of the Conference Sponsors

Membership and Wider Stakeholder Communication

HERA continued its effective stakeholder communication via the monthly HERA News in both printed and electronic format. HERA is pleased to note that our Director's, Guest and Industry Development Manager's comments have been increasingly picked up by other media as significant expressions of industry opinion.

HERA's web site continues to enjoy good visitor numbers with over 2,000 page views each month from New Zealand alone. A web site section to provide Christchurch members affected by the earthquake with links to draw support from the wider HERA membership was also well-received.

HERA Position on Public Policy Issues

In the HERA Strategy, the HERA Director in conjunction with the HERA Executive is charged to develop, maintain and communicate the HERA position on Government policy. As reported in the joint message of the Chairman and Director, this role has particularly focused on promoting the benefits of local fabrication, manufacturing for export and R&D policy.

Multiple submissions and presentations have been made, and input injected into the NZ Energy Strategy, MSI Review of the Access to and Uptake of R&D in the High Value Manufacturing and Services Sector, and especially the promotion and acceptance of the NZTE/ICN draft guide for "Developing and Implementing Local Industry Participation Plans". Also, through its membership of the Construction Industry Council (CIC) and Independent Research Association NZ (IRANZ), HERA contributed on Government policy on behalf of the wider sector.

Work with Related Organisations e.g. SCNZ, NASH, NZSSDA, LAM-NZ

HERA member companies use a wide spectrum of metals and fabrication technologies, and therefore HERA staff have wide cross-sector engagement. HERA staff are represented at Executive or Board level on Steel Construction NZ (SCNZ), National Association of Steel-framed Housing (NASH), NZ Stainless Steel Development Association (NZSSDA), Light Alloys Manufacturing NZ (LAM-NZ), and the Aotearoa Wave and Tidal Energy Association (AWATEA).

HERA provides the secretariat for newly-formed Metals NZ, the NZSSDA and accounting services for SCNZ, NASH, NZSSDA and LAM-NZ. HERA also leases office space to SCNZ, NASH and the Auckland representative of the Manufacturers and Exporters Association (MEA).

Towards Developing a NZ Marine Energy Industry

Following increased contact between HERA members and European marine energy device developers, and as an outcome of the HERA trade delegation visit to the UK last year, the opportunity to develop a *New Zealand Marine Energy Centre* (NZMEC) has been pursued as a joint activity between HERA and AWATEA.



The proposal is at an advanced stage of development, with the stakeholder working

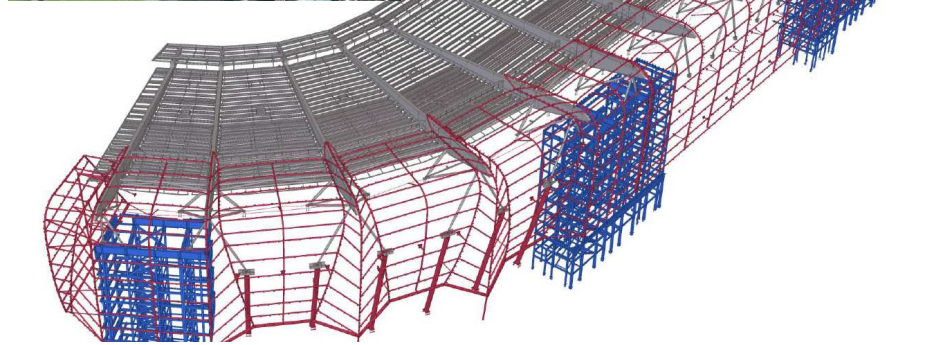

Eden Park re-development: Auckland-based HERA member BDS Vircon was contracted by 3 fabricators - HERA members Culham Engineering, Graysons Engineering and Jensen Steel Fabricators - to provide workshop drawings and CNC data for fabrication of the steelwork. Unique to this project, was that the design information for the Facade steelwork and ETFE sheeting was provided largely by sharing 3D model files, rather than conventional 2D drawings. A collaboration which contributed towards the success of the project.

group being chaired by HERA Industry Development Manager Nick Inskip.

The proposal includes a 'twinning' agreement with the European Marine Energy Centre (EMEC) in Orkney, Scotland. This activity is one of the HERA Industry Development Roadmap Processes currently being undertaken and is a catalyst around which a New Zealand marine energy industry will develop to service the Asia / Pacific market.

Establishing NZ Geothermal Incorporated

The extensive experience of New Zealand and HERA members with geothermal developments means that we are well-equipped to take our geothermal expertise to the global market. HERA has been working with a wider group of stakeholders to explore how mechanisms can be developed for New Zealand industry to move forward into the geothermal export marketplace as part of a NZ Geothermal brand.

In support of these activities, HERA has hosted a workshop, and participated in extensive meetings and forums which have steadily moved towards a positive outcome. In support of the development of a competent NZ geothermal brand, HERA also published an updated version of the *Geothermal Capability Register* R5-35:2010, which is freely available for download from the HERA web site.



WET-NZ's half-scale wave energy device fabricated by Stark Brothers in Lyttelton being deployed for trials



HERA member SKM was engaged as engineering designers for the steam separation system at Nga Awa Purua—a new 140MW, \$430 million geothermal power station in Taupo. Nga Awa Purua houses the largest single shaft geothermal turbine in the world and provides enough electricity to power 140,000 homes (equivalent to Taupo, Rotorua, Hamilton and Tauranga combined).



Repair of extensive erosion damage to turbine rotor labyrinth diameters, built up with Inconel 625, by HERA member Allied Industrial



Andrey Savchenko from Optimech working on a turbine at Contact Energy Taranaki power station

KEY STRATEGY 2
To drive the development of technology, systems and products

HERA's role in driving the development of technology, systems and products is addressed in developments for sector groups. These include steel construction, general heavy fabrication, or material-specific fabrication, e.g. for stainless steel, or more generally for welding-based fabrication, or often in confidential developments for individual companies.

Development of Standards and Guidelines

Research related to sector groups usually ends up in guidelines, as well as national and international Standards benefitting not just members, but the larger engineering community and end users. In pursuing this work, HERA staff members are represented on numerous national and international standard committees.

- Revision to Australian Hot-dip Metallic-coated Steel Sheet and Strip Standard

Dr Stephen Hicks represented New Zealand interests as an Observing Member on the AS1397 Committee. The Draft for Public Comment period concluded in February 2011, and it is expected that the new Standard will be published in the latter half of 2011. This Standard improves the requirements given in the existing AS 1397 and introduces the following three new coating types: Zinc and aluminium (Type ZA); Zinc, aluminium and magnesium (Type ZM); and Aluminium, zinc and magnesium (Type AM).

- Revision to Australian Bridge Design Standard

This year, Dr Stephen Hicks was invited to become a Participating Member on the AS5100 *Bridge Design Committee* as the sole representative from New Zealand. He was elected as Chair of the AS5100-6 *Steel and Composite Construction Sub-committee*. Some of the issues in AS5100 that were identified during the development of the draft '*Steel-concrete Composite Bridge Design Guide*' have been put forward for the Committee's consideration.

- Revision of AS/NZ Welding Standards

The NZWC represents New Zealand welding fabricators on the joint AS/NZ *Welding Standards Committee* WD-003 *Welding* and ME-001 *Pressure Equipment*. NZWC staff have managed the project to revise the *Stainless Steel Welding Standard* AS/NZS 1564.6 with the outcome that the draft document for public

comments was published and comments have been received. The intention is to submit the completely revised Standard for publishing by the end of 2011. The NZWC has also been actively involved in the revision of other welding Standards such as AS/NZS 1554 part 1 and 5.

Improving the Competiveness of the Steel Construction Sector

HERA's Structural Systems division provides sector overarching and company-specific R&D to the metals-based construction industry:

- New Zealand Steel Floor Deck Products Go From Strength-to-strength

Working closely with Tata Steel International, Structural Systems extended the work that was undertaken in 2010 on the ComFlor 60 and ComFlor 80 products in New Zealand-made high strength steel. The new work consisted of evaluating the design properties from tests according to the structural reliability method given in EN 1990 using finite element models to investigate the sensitivity of material strengths and geometrical tolerances.

The additional benefit of using harmonized Standards in the assessment is that the work will facilitate CE marking of the products, which is mandatory in some countries to facilitate market access.

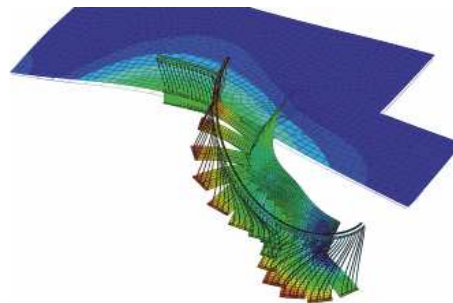

Floor and stair vibration mode from HERA FE analysis

Another additional benefit of these decking developments is that associated highly-specialised roll-forming equipment is also developed in New Zealand, leading to export opportunities for equipment suppliers. The roll-formers used to produce the ComFlor products were supplied by Tandarra Engineering.



Roll-forming equipment manufactured for export by HERA member Tandarra Engineering

- Design of Structures Against Human-induced Vibrations

Through the *SCI P354 Design Method* co-authored by Dr Stephen Hicks, HERA Finite Element Analyst Nandor Mago provided predictions of the anticipated vibration response to the adjacent floor from walking activities on a spiral staircase. As well as accurately predicting the maximum response so that comparisons could be made with internationally acceptable criteria, the benefit of using this methodology was that - as opposed to traditional design methods that provide a rating for the complete structure - specific areas where the vibration response was more significant could be identified.

This can be useful in choosing locations for particularly vibration-sensitive areas within a building, or for ascertaining which areas of a structure need to be modified. HERA has also assisted a number of clients using this method for office, residential and laboratory floors.

- HERA Invited on a Major European Fire Research Programme



Dr Stephen Hicks was invited as the only non-European representative to

participate in the European Cooperation in Science and Technology (COST) action entitled '*Integrated Fire Engineering and Response*' (IFER), which includes researchers and specialists from 18 European countries. It aims at providing specific applications on the performance-based fire safety design methods to practitioners, and introduces the latest international research into Standards for fire design. It is hoped that the output from this work can be used in the development of the new fire section in NZS3404, which is currently underway, together with the update to the HERA *Slab Panel Method* (SPM).

- Steel Bridge Development Group Launches New Campaign

Since 2004, the Steel Bridge Development Group has been the main driver behind the increase of structural steel in New Zealand bridges. This is being achieved by promoting the use of steel in bridges, providing technical advice on design issues, durability design guidance and providing preliminary design options for the most cost-effective solution for every bridging project. To better reflect its direction, the Steel Bridge Development Group underwent a re-branding exercise last year which led to a new logo.



Steel Bridge Development Group brochure – Why Use Structural Steel in Bridges?



HERA seismic design solutions are now in every multi-storey building in New Zealand. Aurecon's International Structural Engineers UK award-winning Te Puni student accommodation building is shown here. It incorporates damage avoidance systems such as rocking frames (shown inset) and sliding hinges

- Design Guide on Composite Bridges

Through generous support from the New Zealand Transport Agency (NZTA) and the steel industry, the first draft of the *New Zealand Composite Design Guide* was launched at a series of national seminars. The publication is prepared by Raed El Sarraf, David Iles of the UK Steel Construction Institute and David Easley of AECOM. The Design Guide is based on AS5100 and when completed, will be complemented by a number of worked examples.

- Composite Structural Assemblies (CSA) Project Completed

The CSA project united a group of companies and research providers under a common goal to build cost-effective structural steel-based composite assemblies for the building sector, and more particularly for export. A vast amount of IP in the form of patented product solutions and production know-how has been assembled. However, further work to reach commercialisation was still required. The joint venture contract came to its end in September 2010, and the project has been put on hold as an application for Government funding support was unsuccessful. Current industry investment constraints also did not allow continuation. Exploration of alternative ways to utilise the developed IP are ongoing.

Heavy Engineering – Focus Clean Energy Business Opportunity

Significant work was undertaken during the year to further develop the HERA *Industry Development Roadmap Process*. The Roadmap Process identifies emerging market opportunities, companies which have an interest or potential to successfully operate in the market, and research that can support companies in developing products for the market. The Process has been used to identify two broad areas for potential development for New Zealand heavy engineering.

The first of these is the *low enthalpy heat-to-electrical energy conversion* area. This is market-driven by extensive global hydrothermal resources and the presence of significant energy in the form of waste heat, particularly in traditional legacy industries such as, oil refining, steelworks and cement production. This potential market has a high number of niche sectors, offering a range of opportunities for HERA member companies to consider. A programme of research has been developed as part of the Roadmap Process, and market studies undertaken. These include the production of HERA reports: *Geothermal Market Analysis*,



Flare Stack designed and built by HERA member Vortex Engineering for OI Glass expansion project in Penrose, Auckland. HERA member Grayson Engineering, fabricated the stack as part of a \$1.2m contract involving approx 250 tonnes of support steel for the waste gas cleaning plant upgrade with the fitting of an Electrostatic Precipitator.

R3-75 & Low Enthalpy Heat-to-Electrical Energy Market and Technology Assessment, R3-76.

A research programme to support HERA member companies to develop products for identified market opportunities has been successful at securing funding, and a research team has been established at Canterbury University. The outcome of this programme will be the development of design tools for use by HERA member companies, as well as the design, development and deployment of two 250kw, Organic Rankine Cycle demonstration plants.

NZWC - Increasing Productivity in Welded Fabrication

The New Zealand Welding Centre (NZWC) division advises industry members on a daily basis on welding-related matters, and plays an important role to improve welding productivity and quality. This can be in the form of much sought-after free advice of limited duration, or in the form of commercial consultation. This year, a research programme largely funded by the HERA Welding Consumable Levy had a very strong productivity focus.

- Gaining Confidence in the Use of Lower Cost Stainless Steel

Recent developments in the price of traditional stainless steel has stimulated interest in the application of alternative grades of stainless steels. These include less costly ferritic and manganese bearing grades, some of which are now available on the NZ market. The cost-effectiveness in industrial applications depends on knowing more about the performance of these alternative grades in the NZ environment.

Since 2009, the NZWC has investigated fabrication aspects, and performance of these grades in the NZ environment, in close co-operation with the NZSSDA (New Zealand Stainless Steel Association) and the University of Konstanz in Germany. The study involves welding trials and subsequent corrosion and exposure tests. Evaluation of test results is ongoing. The first project results were presented at the Metals NZ Industry Conference in Wellington of April 2011. Further publications, including application seminars, are planned for next year.



TIG welding of stainless steel samples used in corrosion test



Exposure test on different grades of stainless steel at Muruwai beach

- Designing Fatigue-Resisting Structures with Fabrication Cost in Mind

Designing welded structures which stand

Technical Papers/Presentations

To communicate their research results, HERA staff presented extensively throughout the year, particularly so at the last Metals NZ Industry Conference.

Papers given were as follows:

- Heavy Engineering Industry Development

- o *Towards a New Zealand Marine Energy Centre*
- o *Heavy Engineering Industry Development Roadmap Process*
- o *Industry in Need of a Roadmap – Casting Industry*
- o *Establishing a Wind Energy Roadmap for NZ's Metals Sector*

- Structural Systems Division

- o *Design of Floor Structures Against Human Induced Vibrations in Steel Construction*
- o *Dynamic Performance of a Brick Veneer House with Steel Framing*
- o *Strength and Ductility of Headed Stud Connectors Welded in Modern Profiled Steel Sheeting in Steel Construction*

- NZ Welding Centre

- o *Corrosion Performance of Alternative Stainless Steel Grades*
- o *Recent Proposed Changes to the Stainless Steel Welding Standard AS/NZS 1554.6*
- o *Cost Effective Fabrication Through Applying Principles of AS/NZS ISO 3834*
- o *Design of Welded Beams - Influence on Cost and Fatigue Performance*
- o *Study of Trends and Productivity in the Welding Fabrication Industry*

up to the demand of dynamic loading remains an ongoing industry challenge. The NZWC has worked towards establishing advanced weld design competence with the aim of assisting member companies.

This year's project initiated by the Bridge Development Group was concerned with the evaluation of competing design solutions for welded girders, and the estimation of welding-fabrication cost associated with each of those. The project results indicate welding cost-savings potential of up to 70%. This can be achieved by shifting from full penetration butt welds to double-sided compound welds without a loss in fatigue resistance. The results were presented at the Metals NZ Industry Conference in Wellington.

In the next year, the NZWC will continue with its focus on productivity, including the stainless steel and fatigue design research. The latter project will be extended into the low cycle fatigue area, as typical for earthquake loading covering the assessment of the remaining life of welded joints subject to an earthquake. The objective is to develop an assessment methodology that will allow rapid evaluation of the remaining life of steel structures at critical locations (welds), and predict their expected lifespan.

New Publications and Reports HERA Reports



HERA Report R5-40 2010: *Imported Steelwork – Economic, Social and Risk Related Impacts*
M Gupta, T Neitzert, N Inskip, W Scholz

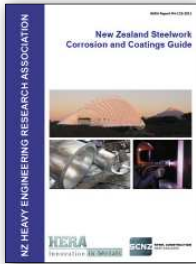

HERA Report R4-133: 2011: *New Zealand Steelwork Corrosion and Coatings Guide*,
R El Sarraf & G C Clifton



HERA Report R5-35: 2010 *Geothermal Capability Register*
The Geothermal Energy register was comprehensively reviewed and updated to include the broader geothermal industry capabilities



HERA Report R4-143: 2011: *Design of Steel-Concrete Composite Bridges Seminar Notes*,
R El Sarraf, D Iles, A Mamtahan & K Cowie



HERA/NZWC Report R8-29: *Characterising the New Zealand Welding Industry*
C Bernon, M Karpenko

Other Reports

Beams with Web-openings Publication

Dr Stephen Hicks co-authored the first technical guide to be presented in the new SCI publications style, entitled 'Design of Composite Beams with Large Openings' (SCI P355). The guide was developed through two major European Commission research projects totalling €1.4M, which were undertaken between 2001 and 2006.



The rules contained within SCI P355 have been put into wide use internationally through design software. One such example are Fabsec beams, which are produced in USA, UK, UAE, South Africa, India and New Zealand.

Right; Designed by Knowles Consulting, this leaf sculpture sits outside Countdown in Hamilton. The leaf sculpture is 17m long by 7m wide fabricated from profiled plate by HERA member Taslo Engineering, Rotorua. It was then transported in one piece to Auckland for zinc spray and coatings.. As with nature, no two components are alike. Many man-hours went into creating the clean lines.

Below: Super yacht Zefira (49.7m) built by HERA member Fitzroy Yachts won the 2011 World Superyacht Award for "Sailing Yacht of the Year"

New Zealand's Engineering Industry

HERA Research Fellow Fern Evitt provided innovation research under contract to NZTE and under the guidance of Industry Development Manager Nick Inskip. Upon completion, a comprehensive confidential report was issued to NZTE - Investment.

Macroeconomic Impacts of Export to the International Marine Energy Sector

Nick Inskip managed the provision of a confidential research report by Infometrics to AWA-TEA for the NZ Marine Energy Centre Proposal.



Super Duplex Salt Dissolver Vessels at HERA member Fitzroy Engineering fabrication yard bound for the Gorgon LNG project West Australia



1-tonne auger with 1,500mm diameter fabricated by HERA member Parfoot Engineering used in the Victoria Park tunnel project



The SkyCabs presentation to HERA members was one of several business opportunity events HERA organised



Tank fabricated by HERA member Page & Macrae with stairs manufactured by HERA member Mobridge



Aerial spray equipment developed by HERA member Oceania Aviation. New Zealand's rugged terrain and hard-to-access farm land means spraying of pasture and forestry is both essential and cost-effective

KEY STRATEGY 3
To assist in the provision of quality workforce required for ongoing industry development

HERA has the role to fill in gaps for essential training not provided elsewhere by public or private training providers. HERA does this through its experts who fulfil dual roles in research and training. Income from this activity was considerably above budget and accounted for 9% of HERA's income.

HERA is the accredited national body to provide welding-related training to *International Institute of Welding* (IIW) qualifications. HERA is also NZQA accredited for welding- and inspection-related training at levels 5 and 6. This allows our students to obtain both International Welding Specialist (IWS) Diplomas and NZQA credits to higher national trade qualifications. HERA successfully passed an IIW WTIA Audit in December 2010 and NZQA Evaluation in March 2011.

NZWC Training Courses and Seminars

The *Welding Supervisor Course* was held in November 2010 in Christchurch, and March 2011 in Auckland with 25 students attending. Two exam rounds took place, preceded by a one-day refresher course, with 18 people achieving their certificates. The Christchurch refresher course was offered for free as a gesture of support to those affected by the earthquakes.

The IWS Course 2010/11 was postponed due to low registration numbers. The main reason for the relatively low demand for IWS qualification is primarily seen to be the length of the course. The range of qualifications offered will be further extended to include *International Welding Inspector* (IWI B and IWI S).



Dr Damian Kotecki

At the invitation of the NZ Welding Centre, former President of the American Welding Society (AWS) Dr Damian Kotecki, visited NZ in October. He is one of the world's leading experts on stainless steel fabrication.

Dr Kotecki presented at a seminar series on *Welding of Stainless Steels* in Auckland, Hamilton, Palmerston North and Christchurch. This seminar addressed important aspects of stainless steel

welding, reflecting up-to-date knowledge from the latest development of welding consumables. Around 55 people attended the event.

WTIA CEO Chris Smallbone, and National Technical Manager of BlueScope Steel John Dryden, gave a free joint seminar at HERA in December 2010. The first section of the seminar covered recent international developments in welding processes, and personnel qualifications and certifications. The second section covered developments in steel Standards for pressure vessels. Around 30 people attended.



From left: Welding Centre Manager Dr Michail Karpenko, HERA Director Dr Wolfgang Scholz, WTIA CEO Chris Smallbone and Welding Centre Engineer Alan McClintock

The NZWC co-ordinated with AUT to organise a free seminar with Dr. Wayne Thomas from TWI, the inventor of the Friction Stir Welding Process. The seminar took place at HERA in February 2011, and attracted more than 40 people. It covered new developments in friction welding technology. NZWC staff presented company specific seminars on aspects of quality management in welding fabrication and transitional issues around the Standard AS/NZS 2980.

NZWC also contributed a session on *Welding Quality Control* to SCNZ's 2011 Autumn seminar series. The seminar was held in Nelson, Taupo, Wellington and twice in Auckland, with around 80 people attending.



A *Welding Procedure* seminar and workshop was developed to cover issues around the development of welding procedures to AS/NZS 1554.1, and to specify the range of welder's qualification according to AS/NZS 2980. The seminar took place in Auckland, Hamilton, Palmerston North, Napier, Nelson and Christchurch in May 2011. More than 100 people attended. Following the seminar, NZWC published an updated guideline on the transition from NZS 4711 and 4703 to AS/NZS 2980, including typical examples of welding procedures and welder qualification certificates.

At the invitation of the NZWC, Prof. Grzegorz Glinka from University of Waterloo, Canada, gave a seminar series on "*Design to Avoid Fatigue in Welded Structures*". The series included a session presented by Dr. Michail Karpenko on the NZWC fatigue research. Prof. Glinka, a world expert on the subject, presented in Auckland, Hamilton, Wellington and Christchurch. The series was followed by a two-day workshop in Auckland. More than 60 people attended both events, and especially noteworthy was the high number of interested young consulting engineers.

Inspection & Quality Control (I & QC) Centre

The I & QC Centre is assisting both the fabrication and the inspection industry. It plays a key role in the provision of skilled inspection and quality control personnel. I & QC Centre Manager Peter Hayward, who officially retired last year, continues to provide services on a part-time basis. We made several attempts to find a suitably qualified and experienced person, but our attempts were repeatedly unsuccessful, due mainly to immigration-related issues. Thanks to Peter's willingness to continue, we are able to provide a full range of training courses and core advice services. Citing financial constraints, HERA has decided to operate at least another year on this basis.

Below: International welding expert Prof Grzegorz Glinka with participants of the Auckland seminar on Design to Avoid Fatigue in Welded Structures



HERA member Tenix New Zealand was awarded a contract to design, fabricate and deliver four mounded pressure vessel 'bullets' for Transfield Worley Services Ltd. The pressure vessels are for a new Liquefied Petroleum Gas (LPG) Recovery, Storage and Load-Out project at Todd Energy's McKee Oilfield Production site in Taranaki.

Structural Systems: Design of Steel-Concrete Composite Bridges

As part of a Steel Bridge Development Group initiative, a joint HERA/SCNZ seminar series in February 2011 attracted a great deal of interest at the venues of Christchurch, Taupo and Auckland. The presentations were led by David Iles from the UK Steel Construction Institute, who was complimented with presentations from HERA, SCNZ and AECOM.



David Iles from SCI UK

2010/11 - Metals Industry Successes:



Clarks Lane footbridge, a cable stayed steel box beam with in situ concrete deck, over new SH18 Hobsonville Deviation which opened August 2011. Designed and built by HERA members Jasmox, Jeff Wells, Aurecon, Eastbridge and HEB Construction.



New Forsyth Barr Stadium in Dunedin. HERA member Grayson Engineering used 3,750 tonnes of steel mainly for the pipe trusses.



Two 48m grind thickeners and reagent infrastructure built by HERA member Tenix New Zealand for client Newcrest at their Lihir gold mine in Papua New Guinea. In addition, Newcrest also awarded packages to install 190 tonnes of pipe racks and also to install 9km of small bore piping and mechanical plant to the NCA tanks Tenix supplied the previous year.



Marine industry services are of strategic importance to the remote island nation New Zealand. In the photos Babcock Fitzroy provides maintenance services to the cement carrier Golden Bay.



In 2009, Fitzroy won an over \$30 million EPC project associated with a mid-life enhancement (MLE) programme for the offshore Yolla gas field platform in Bass Strait, Australia and crucial to this development is enabling the Yolla platform to accommodate project personnel. Fitzroy Engineering's contract is to manage, engineer, fabricate and deliver the new accommodation and utilities "megamodule" to the project. To be shipped in October 2011, this megamodule will be made up of nine units of various sizes and total transport weight will be approximately 630 tonnes. The entire unit will be transported from Fitzroy Engineering's New Plymouth fabrication yards to Port Taranaki and loaded on board a specialist transport vessel to the Bass Strait for installation.



The Novotel at Auckland International Airport under construction by HERA members Hawkins Construction and George Grant Engineering (GGE), contains close to 600 tonnes of structural steel. The 40-tonne front entry canopy was assembled in their workshop in sections, broken down and re-assembled on-site. To lift this canopy into position, two 80-tonne cranes and a 150-tonne crane were used.

KEY STRATEGY 4
To develop and implement tools required for monitoring and enhancing industry growth and competitiveness

HERA maintains and publishes a comprehensive set of industry statistics, and performs research projects relevant to describing industry performance. This year's research programme included:

Industry Capability Research Programme
Building on the research presented in the HERA Report R5-38: "Optimizing Industry Capability Communication", a project was undertaken to map and document the interfaces required for the recommendation of the report to be implemented.

This involved assessing the member database profiling features of HERA's Memberconnex software and identifying an integration pathway. The outcome of the project included splitting the implementation of the R5-38 recommendations into three phases with the first to include development and population of the capability database, the second to include enhanced member communication features, followed by a capability / opportunity matching process in phase three.

Software development is almost complete and population of the database with multiple sub-profiles for members is advancing, with completion expected by early 2012.

Welding Industry Productivity Research Continues

Responding to the requirement for increased international competitiveness of the industry, the NZ Welding Centre continued with its productivity research programme that aims to lift productivity in the welding fabrication environment.

Following last year's statistical analyses of the welding fabrication industry, and the publication of HERA Report R8-29 "Characterization of the New Zealand Welding Industry", the ongoing programme focuses now on the use of quality assurance standard AS/NZS/ISO 3834; "Quality Requirements for Fusion Welding of Metallic Materials" as a tool to improve productivity.

Commitment to TWENTY by 2020



In line with HERA's strategic commitment to productivity improvement, the HERA Executive approved the adoption of the Department for Building and Housing initiative *Twenty by 2020* by our industry. But rather than striving for a productivity improvement of 2% annually only, HERA is putting out the challenge to our industry to double this target to a productivity improvement of 4% annually.

HERA believes that the steel-based construction industry, because its synergy with off-site fabrication and its desire to substantially improve profit margins, has a very good potential for productivity improvement. HERA, through co-operation with BRANZ and sector-groups within Metals NZ, intends to contribute to industry benchmarking via scorecards, and provide guidance and training to our industry to achieve the target.



The steel fabrication industry has invested heavily in more productive plant over recent years. This photo is from the new Welded Beam Line installed at HERA member Dixon and Haddon. The product fabricated here are the Kopu bridge girders.



Hot forming of martensitic stainless hydro turbine runner blades on 1000kg drophammer by HERA member S.A.F.E. Ltd



Auckland New Market southern concourse railway station undertaken by HERA member GGE for Hawkins Construction with glass-finished paint systems, interconnecting links. The roof sections shown were erected during night hours, assembled on-site upside down, then flipped upright and hoisted upon the columns.

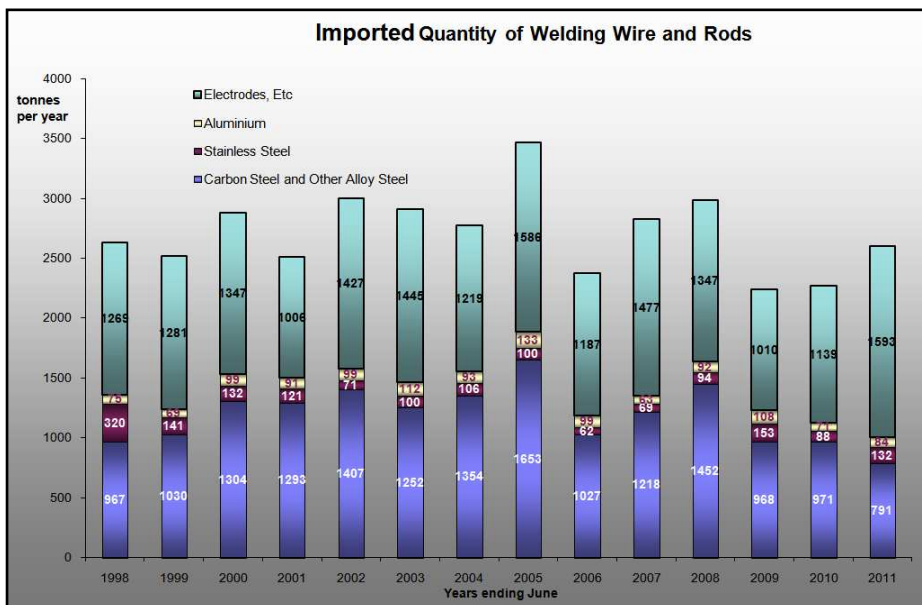

Changes in the use of welding consumable types are indications for changes in welding productivity. Source: Statistics NZ/HERA

KEY STRATEGY 5
To improve the HERA organisation by enhancing services and improving cost/benefit ratio

HERA Strategy Review and Execution

This year, HERA Executive and staff engaged in a wider strategy review. Part of the review was an extensive membership survey on the future direction of HERA.

While most of the HERA key strategies were confirmed as cornerstones, a new focus on profitability of the industry, and a more commercial approach for HERA to doing business were the main outcomes. In an effort to have a more refined focus, the strategic emphasis was limited to 5 'drives' as outlined in the following diagram.

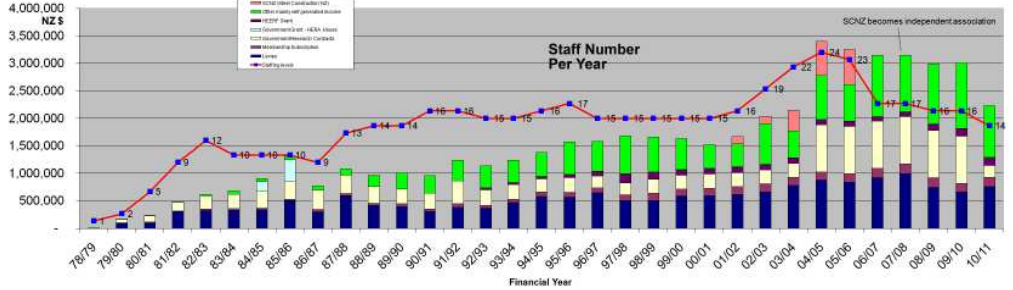

Development of HERA funding and staff numbers

HERA Executive Strategy Workshop - Outcomes

Limit Focus to 5 Drivers

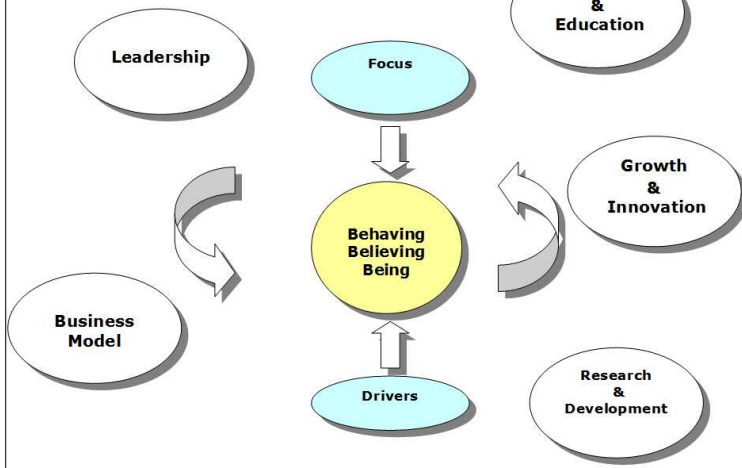

Members of the HERA Executive and staff met with the Minister of Science and Innovation, Dr Wayne Mapp, to discuss the request to amend the Heavy Engineering Research Levy Act 1978.

As part of the review, a clearer and simpler Vision and Mission statement was also adopted:

Revised HERA Vision: The HERA Vision is to have NZ's Metals Engineering Industry achieve world class standards for profitability, quality and sustainability

Revised HERA Mission: HERA to be the catalyst for research, innovation, growth and development in the NZ Metals Engineering Industry

these changes in contract research co-funding, HERA staff numbers dropped from 16 to 14. Investment in capital equipment has been kept to an absolute minimum.

The industry-supported request for increasing the HERA industry funding via the Amendment of the Heavy Engineering Research Levy Act was pursued with vigour. However, despite having achieved the assurance of all major political parties for the amendment, HERA is facing continued delays in its introduction, due to higher priority Government initiatives.

The overdue refurbishment of the HERA House Atrium and offices has been delayed for a second year based on the Executive's decision to commence refurbishments only if more stable long-term HERA funding has been secured.



Oxygen processing plant built by HERA member Tenix New Zealand for the Lihir gold mine on Lihir Island, PNG

HERA Funding Issues

As noted in the Chairman's message, HERA was under considerable pressure due to losing out in the last contestable Government research co-funding round, and was constrained by the drop in levy income.

Consequently, income from Government contracts dropped from 30% last year to 10%, while industry income from the levy and self-generated income increased. As a result of



As an incentive to participate in the HERA Strategy Survey, HERA offered a family dinner for the winner of a draw. The winner was Barry Robinson from S.A.F.E Ltd who took his family to a lovely teppanyaki dinner.



Steel work (featuring HERA member Grayson Engineering's Cellbeams) at the Britomart East one and two project, Auckland. The \$11m project used approximately 3,000 tonnes of steel.

KEY STRATEGY 6
To maintain and strengthen top-class research and industry training capabilities

Ensuring Research Capabilities are Available and Accessible for Metals Industry

In conjunction with its industry research roadmap and in its role as a research management organisation, HERA is concerned about development and maintenance of relevant research capacity and capability across New Zealand. Because of New Zealand's small size, it is critical that co-ordination amongst and across resources is effective.

The HERA submission to the CRI Taskforce and the MSI review of improved industry access to Government-funded research led to an increased recognition of the links to industry that HERA could provide for research providers. A series of engagements with the CRI Industrial Research Limited (IRL) explored this co-operation potential, and included IRL contributing to this year's Metals NZ conference in the form of being a sponsor, presenter and facilitator of industry visits to its Gracefield research facilities.

HERA continued its activities with the Engineering and Business Schools of Auckland University, AUT, and Canterbury University, mainly through the HERA/HEERF sponsored Master's and PhD studies. The link to BRANZ has been maintained and included continued advocacy for an increased share of BRANZ research for our industry in line with its contribution to building activity, and therefore to BRANZ levy funding.



Therefore, HERA in conjunction with Metals NZ will continue to contribute to the formulation of the BRANZ research strategy and achieved advancement of our sector.

HERA has been an active member of IRANZ (Independent Research Association of NZ) which advocated in favour of undertaking activities aimed at creating a positive operating environment for independent i.e. non-government owned research organisations.

HERA and IRANZ believe that through effective end-user engagement, independent research organisations make vital contributions to innovation and offer an



A 25-tonne section of a hydro power station penstock used to divert water to an irrigation scheme fabricated by HERA member Fitzroy Engineering for Trustpower's Highbank power station at the Rakaia River in mid-Canterbury

important complement to university-based and Crown Research Institute research.

Link to International Research and Industry Associations

HERA actively participates in international research developments and in the process, maintains links with numerous leading technical organisations throughout the world. This year's active projects included collaboration of the Structural Systems Division with the Australian Steel Institute (ASI) and the Steel Construction Institute (SCI) in the UK.



The NZWC has a traditionally strong cooperation with the *Welding Technology Institute of Australia* (WTIA) in virtually all business areas. Through the *International Institute of Welding* (IIW) there are strong links to a variety of leading welding research institutions and the NZWC performs its research in close cooperation with top international experts maintaining high quality in its research.



Hosted by SCNZ, the members of the International Steel Construction Group met at Paihia for an update on global industry developments

HERA Support for Development of Industry Training Capability

One of the strategic roles that HERA plays is providing advisory services to ITOs and training providers, and making contributions to career development and NZQA unit Standards. This year's achievements included involvement in a working committee for the development of a CNC Centre of Excellence, Advisory Board roles at the Mechanical Engineering Department of the University of Auckland, the Engineering School of AUT University, the Industry Advisory Committee of MIT, the *Competenz Sector Advisory Group for Fabrication and Welding* and the *ACC Metal Manufacturing Safer Industry* programme.

Apart from its role as IIW and NZQA-approved training provider, HERA plays a major role in advancing national and international training capabilities, including the education of trainers. It continually develops new courses, develops and provides educational material to academic and private training providers, and runs its courses in co-operation with other providers and in particular, NZ polytechnics.

NZWC Training Materials

The International Welding Specialist (IWS) training material, student notes and presentations developed by the NZWC continued to be used by the WTIA's OzWeld School for IWS training in Australia under a Licence Agreement with HERA. HERA's Welding Modules have continued to be used at polytechs and other training providers. However, the overall number of modules and licenses sold has dropped compared with the previous year. NZWC Manager Dr. Michail Karpenko participated in the 63rd IIW Annual Assembly, and gave a presentation on training resources available from HERA for the wider international audience.

Closer cooperation with International Steel Construction Organisations

SCNZ in co-operation with HERA played host to the International Steel Constructors Group (ISCG) which is the English speaking grouping of steel construction organisations and includes the American Institute of Steel Construction (AISI), the Australian Steel Institute (ASI), the British Steel Construction Association, (BCSA), the Canadian Institute of Steel Construction (CISC) and the South African Institute of Steel Construction (SAISC).

Thanks to Paihia as conference venue and a series of industry visits to show-

case steel construction innovation in New Zealand, we were able to showcase our country and achievements, and share worldwide developments in our industry sector.

HERA Gains Membership of International Composite Construction Technical Committee

Last year, the European Convention for Constructional Steelwork Technical Committee 11 (ECCS TC11) '*Composite Structures*' appointed Dr Stephen Hicks as Expert Member.



In Europe, the design guidance developed through the TC has strongly influenced the contents of the structural Eurocodes as well as other international Standards.

Through the membership of ECCS TC11, it is hoped that the latest international research findings and design rules can be incorporated within the new design of composite part of the Steel Structures Standard NZS3404.4, and the revision of the steel and composite construction part of the *Bridge Design Standard* AS5100.6.

KEY STRATEGY 7
To work towards a more sustainable Metals Engineering industry

Sustainable Steel Council Established
The Sustainable Steel Council is an initiative that supports the wider Metals New Zealand activity of promoting the sustainability of metal products. The Sustainable Steel Council's goals are:

- To be the representative voice of the steel and associated design & manufacturing industries;
- To promote the use of steel as a sustainable material in the building and construction industries; and
- To be the primary source of information for the steel industry.



Under the chairmanship of Dr Stephen Hicks, the Sustainable Steel Council commissioned PE International to develop a 5-year roadmap document. It has also been forging links with international bodies such as Worldsteel, Australian Steel Institute (ASI) and the British Constructional Steelwork Association (BCSA).

Metals New Zealand Industry Conference - Sustainability: It's Your Business

At the Metals NZ Industry Conference, both Dr Stephen Hicks and Dr Roger Pope delivered the presentation entitled 'Sustainability: It's Your Business'. Stephen described: Why the New Zealand steel industry cannot afford to ignore sustainability in its current and future business activities; Why the Sustainable Steel Council has been formed; What sustainable work practices may need to be adopted by the sector to ensure that steel solutions are not disadvantaged and that business is not lost to competitors.



Dr Roger Pope, who is a specialist technical consultant to the British Constructional Steelwork Association (BCSA) and Tata Steel Europe provided an international perspective with respect to current European activities in sustainability, and discussed: *Zero Carbon Steel Solutions; Impacts on Selection of Steelwork Contractors; and Responsible Sourcing.*

Thermal Resistance of Light Steel Frame Walls

NZS 4214:2006 provides a hand calculation

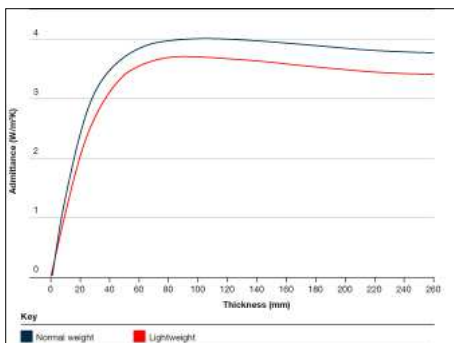

Optimising thermal mass in floor slabs: Admittance of normal and lightweight concrete is unchanged beyond 100 mm thickness

method for establishing the thermal resistance of parts of buildings. Although this Standard is useful, much more accurate predictions of the air-to-air thermal resistance (R-value) can be made using heat transfer analyses.

Over the last year, HERA FEA analyst Nandor Mago has assisted a number of clients using heat transfer analyses to enable them to enhance/optimize their construction details to achieve a particular R-value requirement. As well as accurately modelling different thermal conductivities of the layers that form a wall or roof element, this procedure can be used to identify the main heat flow pathways to enable construction details to be refined and to increase the corresponding R-value.

Thermal Mass in Floor Slabs

Thermal mass is the ability of the fabric of a building to absorb excess heat, thereby reducing cooling loads and, in some cases, removing the requirement to provide air conditioning entirely and its associated energy consumption. Through working closely with the British Constructional Steelwork Association (BCSA), Richard Green and Dr Stephen Hicks showed that over a typical 24-hour cycle, the maximum value of admittance for a slab exposed from underneath may be achieved with only 75-100mm of concrete. This means that, where heating and cooling takes place over a daily cycle, a floor thickness of 100 mm (typical of steel composite construction) will provide the maximum amount of fabric energy storage possible. If more mass is provided, it will not be utilised and is a waste.



Dedication to Richard Green

Richard Green sadly passed away at his workplace on 21 st-February 2011. Richard joined HERA in 2006 as the Technical Research Manager for the Composite Structural Assembly (CSA) research programme. He also held the role of HERA Sustainability Steward.



Hamilton-based HERA member Advance Boiler Services Ltd tackles import replacement work with their fabrication of an oil heater for use in the pulp processing industry.



Page Macrae Engineering continues its export drive of bulk handling solutions which includes its Australian Bulk Handling Awards winning hopper-grab combinations. The photo shows the 10cum diesel-hydraulic grab and hopper in operation at Bunbury in Western Australia.

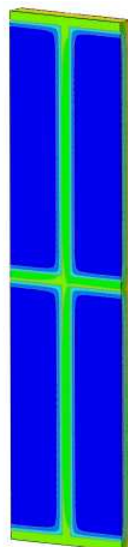

FEA of thermal resistance of framed wall solutions allows for optimisation of construction details to achieve a particular R-value requirement



HERA is contributing to light steel framed housing technology development, a construction system which steadily increases its market share

AUDIT REPORT

We have audited the summary financial report of the New Zealand Heavy Engineering Research Association Inc aka HERA, and the Heavy Engineering Education and Research Foundation aka HEERF for the year ended 30th June 2011.

Responsibilities of Executive and Auditor

The Executive members are responsible for the preparation of a summary financial report in accordance with generally accepted accounting practice in New Zealand; It is our responsibility to express to you an independent opinion on the summary financial report presented by the Executive.

Basis of Opinion

Our audit was conducted in accordance with New Zealand Auditing Standards and involved carrying out procedures to ensure the summary financial report is consistent with the full Annual Report on which it is based. We also evaluated the overall adequacy of the presentation of information in the summary Annual Report against the requirements of FRS-39: Summary Financial Reports.

Other than in our capacity as auditor, we have no relationship with or interests in the New Zealand Heavy Engineering Research Association (HERA) and Heavy Engineering Education and Research Foundation (HEERF).

Unqualified Opinion

In our opinion, the information reported in the summary annual report on relevant pages complies with FRS-39: Summary Financial Reports and is consistent with the full Annual Report from which it is derived and upon which we expressed the unqualified audit opinion referred to above.

We have completed our work for the purposes of this report on the 13th of September 2011.



CST Nexia Audit
Chartered Accountants
Manukau City

STATEMENT OF FINANCIAL PERFORMANCE FOR YEAR ENDED 30 JUNE 2011

	Note	2011	2010
Revenue		\$	\$
Levies (Steel & Welding Consum.)		758,325	658,311
Government Research Contracts (GRC)	10	214,434	857,733
GRC-Deferred Income	10	28,839	340,263
Consultancy and Industry Project		334,489	444,702
Services to 3rd Party		54,268	14,713
Member Subscriptions		169,068	160,519
Interest		962	10,450
Other Income		38,475	12,585
Publications		36,549	36,287
Welding Modules		31,470	50,669
Rent		79,430	74,246
Metals Conference		117,702	-
Seminars & Courses		198,067	210,493
HEERF		149,076	136,048
Transfer from Backdated Welding Levy	10	14,661	-
Total Revenue		2,225,815	3,007,019
Expenditure			
Staff Expenses		1,073,901	1,302,644
Member Services		67,950	96,379
Office & Other Expenses		137,757	149,256
Seminar Expenses		72,536	62,704
Consulting Expenses		12,005	71,667
Metals Conference		117,702	-
External Research		423,214	1,013,524
HERA House Expenses		73,128	75,049
Rent Expenses		206,860	206,860
Depreciation Expenses		69,355	84,763
Total Expenditure		2,254,408	3,062,845
NET (Deficit) SURPLUS FOR THE YEAR		(28,593)	(55,826)
Equity beginning of Year		232,685	288,041
Equity at the End of Year		204,092	232,685

BALANCE SHEET AS AT 30 JUNE 2011

REPRESENTED BY	Note	2011	2010
Assets		\$	\$
Current Assets			
Cash at Bank	2	68,336	51,743
Term Deposits	3	20,338	154,017
Accounts Receivable	4	197,146	187,228
Inventory		9,132	8,696
Other Prepayments	5	64,072	55,815
TOTAL CURRENT ASSETS		359,024	457,499
Non Current Assets			
Fixed Assets	6	132,326	188,281
TOTAL NON CURRENT ASSETS		132,326	188,281
TOTAL ASSETS		491,350	645,780
Equity & Liabilities			
Accumulated Funds			
Accumulated Funds	7	204,092	232,685
TOTAL EQUITY		204,092	232,685
Current Liabilities			
Accounts Payable		118,272	191,477
GST Payable		4,500	-
Holiday Pay Provision		33,905	50,504
Income in Advance	10	130,581	171,114
TOTAL CURRENT LIABILITIES		287,258	413,095
TOTAL EQUITY & LIABILITIES		491,350	645,780

The specific disclosures included in the summary financial statements have been extracted from the full financial report dated 20/08/11. The summary financial statements cannot be expected to provide as complete an understanding as provided by the full financial statements. A full set of the audited financial statements is available on request from HERA.

NOTES

1. Statement of Accounting Policies

(a) General Accounting Policies

The Heavy Engineering Research Association (HERA) follows Generally Accepted Accounting Principles (GAAP) recognised as appropriate for the measurement and reporting of earnings and financial position on historical cost basis. Accrual accounting is used to match expenses and revenues. Reliance is placed on the fact that HERA is a going concern.

HERA is an Incorporated Society and these financial statements have been prepared in accordance with the Incorporated Societies Act 1908.

(b) Particular Accounting Policies

The particular accounting policies, which materially affect the measurement of financial performance and the financial position, are: The Association is exempt from income taxation and therefore there is no income tax liability.

Fixed assets are valued at cost less depreciation. Depreciation has been calculated on all fixed assets using the straight-line method at rates varying between 10% - 40% based on cost.

Books held as inventory are valued at the lower of cost or net realisable value on a FIFO basis after due allowance for damaged or obsolete books.

HERA is a qualifying entity under the New Zealand Society of Accountants Differential Reporting Framework.

The Association qualifies under the size criteria. The Association has not taken advantage of the differential exemptions available to it in respect of FRS 19 – Accounting for GST. Except for this, the association has taken advantage of all other exemptions available to it under the differential reporting framework.

(c) Changes in Accounting Policies

There have been no changes in accounting policies. Accounting policies have been applied on a basis consistent with previous years.

	2011	2010
2. Cash at Bank		
Current Account	62,720	43,514
CSA	5,616	8,229
	68,336	51,743

3. Investment

Call Account	20,338	154,017
Term Deposit - National Bank	-	-
Term Deposit – BNZ	-	-
	20,338	154,017

4. Accounts Receivable

Trade Receivable	203,012	187,228
Less Doubtful Debt	(5,866)	-
	197,146	187,228

5. Other Receivables & Prepayments

Accrued Income	56,477	55,236
GST	-	579
Prepayment	7,595	-
	64,072	55,815

6. Fixed Assets

	COST	ACCUM. DEPRECIATION	NET BOOK VALUE
2011			
Metallurgy Equipment	12,430	12,430	-
Office Furniture	20,306	19,036	1,270
Fixtures & Fittings	82,955	79,641	3,314
HERA House Refurbishment	147,053	65,275	81,778
Motor Vehicles	156,980	139,674	17,306
Office Equipment	199,497	172,644	26,853
Training Equipment	86,037	84,232	1,805
	705,258	572,932	132,326

2010

	COST	ACCUM. DEPRECIATION	NET BOOK VALUE
Metallurgy Equipment	12,430	12,430	-
Office Furniture	20,306	17,954	2,352
Fixtures & Fittings	82,955	74,066	8,889
HERA House Refurbishment	147,053	50,569	96,484
Motor Vehicles	156,980	117,344	39,636
Office Equipment	196,917	163,331	33,586
Training Equipment	86,037	78,703	7,334
	702,678	514,397	188,281

7. Accumulated Funds

Opening Accumulated Fund	232,685	288,511
Net Surplus	(28,593)	(55,826)
	204,092	232,685

8. Operating Lease Commitment

	2011	2010
The commitments are as follows:		
Current	-	5,718
Non Current	-	-
Total payable for the lease contract	-	5,718

9. Related Party Transaction

Heavy Engineering Educational and Research Foundation (HEERF) is a related party to the Association. It is related by the administrative and management expertise the Association provides to the Foundation, in the form of grants provided to the association for the research projects it undertakes. It is also the Association's landlord, owning HERA House.

10. Income in Advance

Majority of Revenue in Advance represent income in advance from various agencies, which funds the Association for research and services. The funding received for programmes (projects) that were completed during the year is recognised as revenue in that year.

Government Research Contract - Composite Structural Assemblies

The project concerned with funding from FRST is the Composite Structural Assembly (CSA) project which was completed in September 2010. Therefore the unspent balance of \$6,341 (2010:\$28,839) has been treated as income in advance.

Backdated Welding Levies

The Association has been advised in June 2005 by NZ Customs Service that the new levy rate set in March 2003 of 5 cents per kg of welding consumables has not been applied for imported welding consumable. Therefore, only the old rate of 2 cents per kg was collected.

As advised by the NZ Customs service, the total backdated consumables levy amount owed to HERA was \$214,399. In 05/06 year \$176,812 was received, in the year 06/07 \$31,193 has been received and in the year 07/08, an additional \$4,822 has been received. The remaining amount of \$1,572 is written off as the importer went into receivership.

HERA has agreed with the welding supply companies that the backdated welding levy will be exclusively for welding industry purpose and only following consultation with the NZ Welding Centre panel and welding supply industry. \$14,661 (2010: \$Nil) has been used in the financial year for dedicated welding projects.

Therefore, the unspent balance of \$115,057 (2010: \$129,718) backdated welding levy has been treated as income received in advance.

Other

The balance of income in advance totalling \$9,183 represents membership for 10/11 paid by members in 09/10 financial year (2010: \$3,987)

11. BNZ Bank Account

The Association has a Visa credit card facility with BNZ. The limit on all cards is \$26,000. (2010: \$33,000)

12. Audit Fees

Audit fees have been included in office and other expenses to the value of \$5,000 (2010: \$5,000). There was no other remuneration paid to the Auditors.

13. Capital Commitments

As at 30 June 2011 there were no outstanding capital commitments. (2010: \$nil)

14. Contingent Liabilities

As at 30 June 2011 there were no outstanding contingent liabilities. (2010: \$nil)



Noel Davies
 Noel Davies
 HEERF Chairman

Chairman's Report

The Heavy Engineering Educational & Research Foundation (HEERF) is a Charitable Trust established by HERA to promote the study of and understanding of the use of ferrous and non-ferrous metals in the engineering industry. HEERF receives income from the property "HERA House" which HERA settled on the Trust and an endowment fund created in 2005/06 receiving donations from those interested to support the HEERF objectives.

In 2010/2011 the Foundation contributed over \$133k to HERA's research and industry development efforts through the support of engineering students, visiting experts and promoting careers in metal fabrication and engineering. HEERF scholarships included support of two PhD's at Auckland University and one at AUT University and also a comprehensive student research program at Canterbury University.

This year the Metals Industry Conference was held in Wellington and the HEERF sponsored 'Keith Smith Memorial Award for Distinguished Service to the NZ Metals Industry' was handed to Nick Calavrias. Nick is best known in his previous role as CEO of publicly-listed Steel & Tube and for becoming an Officer of the Order of Merit (ONZM) in the 2011 New Year Honours. Nick donated his prize money multiplied by a contribution from D&H Construction back to HEERF with instructions to see this as part of a student award.

As reported last year, the planned refurbishment of the HERA House atrium was left delayed on the request of the HERA Executive until HERA has achieved a more stable funding situation. It is hoped that this more stable situation will be achieved during 2011/12 and refurbishment can commence in the year ahead.

An exciting research and visiting scholar programme has already been outlined to the Trustees for the 2011/2012-year and we are looking forward to ongoing top-class research supporting the future of our New Zealand metals engineering industry.



From left: HEERF Chairman Noel Davies and Keith Smith Memorial Award winner Nick Calavrias with Jean Smith, wife of the late Keith Smith

Statement of Financial Performance for Year Ended 30 June 2011

In line with its objectives, the Foundation funded a number of projects related to the metals engineering industry, including student support for research projects.

Balance Sheet as at 30 June 2011

	NOTE	2011	2010	
		\$	\$	
ACCUMULATED FUNDS				
Equity funds at start of year		2,102,055	1,999,664	
Net surplus for the year		61,567	102,291	
Equity funds at end of year		<u>2,163,622</u>	<u>2,102,055</u>	
REPRESENTED BY				
Current Assets				
Bank		20,733	46,909	
Call Account		88,851	38,313	
ShortTerm Deposit		744,430	658,194	
STD - N. Calavrias		5,129	-	
GST Receivable		445	441	
Endowment Fund		9,593	1,316	
Accrued Income		214	-	
K.Smith-Bequest		<u>34,928</u>	<u>33,536</u>	<u>778,709</u>
Total Fixed Assets	4	1,297,524	1,332,554	
TOTAL ASSETS				
		2,201,847	2,111,263	
Current Liabilities				
Accounts Payable		38,225	5,944	
GST Payable		-	3,264	
TOTAL LIABILITIES		38,225	9,208	
NET ASSETS		2,163,622	2,102,055	

Income & Expenditure for year ended 30 June 2011

	2011	2010
	\$	\$
INCOME		
Rent	206,860	206,860
Interest	35,602	25,696
Bequest Income	-	5,000
Bequest Interest	1,390	882
N. Calavrias Award	5,129	-
Total Income	248,981	238,438
EXPENDITURE		
Blding Maintenance	-	-
Blding Managmt Fee	6,000	6,000
Trust Administration	10,000	10,044
Grants to HERA	133,076	83,708
Bank Charges	108	65
K.Smith Award	2,000	-
Audit Fees	1,200	1,200
	<u>152,384</u>	<u>101,017</u>
Depreciation	35,030	35,030
Total Expenditure	187,414	136,047
Net Surplus/ Deficit)	61,567	102,391

1. Statement of Accounting Policies

(a) General Accounting Policies
 Heavy Engineering Educational and Research Foundation (the Foundation) is a charitable trust established under the Charitable Trusts Act 1957. These financial statements have been prepared in accordance with the Act.

The Foundation follows Generally Accepted Accounting Practice (GAAP) recognised as appropriate for the measurement and reporting of earnings and financial position on historical cost basis. Accrual accounting is used to match expenses and revenues.

(b) Particular Accounting Policies
 The particular accounting policies, which materially affect the measurement of financial performance and the financial position, are:

Income Tax

The Foundation has a charitable status from the Inland Revenue Department, hence is exempt from income tax.

Fixed Assets

Fixed assets have been shown at cost less depreciation. Buildings are depreciated using the straight-line method at 1% of the cost price, Air Conditioning Unit at 6% and Roof & Cladding at 10%.

Differential Reporting

The Foundation is a qualifying entity under the New Zealand Society of Accountants Differential Reporting Framework.

The entity qualifies under the size criteria, and because it is not publicly accountable.

The Foundation has not taken advantage of the differential reporting exemptions available to it in respect of FRS-19: Accounting for Goods and Services Tax.

(c) Changes in Accounting Policies

There have been no changes in accounting policies. Accounting policies have been applied on a basis consistent with previous years.

2. Capital Commitments & Contingent Liabilities

There are no capital commitments or contingent liabilities as at 30 June 2011. (2010: nil)

There were no capital commitments as at 30 June 2011. (2010: Nil)

3. Related Parties

The Foundation is related to New Zealand Heavy Engineering Research Association (HERA). Members of the Foundation are also a member of HERA.

HERA is the tenant of the land and building owned by the Foundation and pays rent. The Foundation pays fees to HERA for the management and administration of the building.

5. Post Balance Date Events

There were no significant post balance date events. (2010:\$nil)

6. Bequest

The income from the bequest is to be applied to a prize which shall be given biannually subject to the term set by the late Mr K.Smith. This bequest is deposited with BNZ. This bequest has been recognised as income.

4. Fixed Assets

	COST	ACCUM. DEP.	BOOK VALUE
	\$	\$	\$
Land	244,602	-	244,602
Land Development	24,489		24,489
Capital Work in Progress*	93,808		93,808
Building Upgrade	151,019	103,795	47,224
Air Condition Units	157,300	65,074	92,226
Building	1,049,091	253,916	795,175
	\$1,720,309	422,785	1,297,524

Total HERA membership as of June 30 2011 was 609 members

AFFILIATE MEMBERS

C J Wallis Pty Ltd
EDL Fasteners Limited
Fletcher Easysteel

Fulton Hogan Ltd
Steel & Tube Holdings Ltd
TBS Farnsworth Ltd

Vulcan Steel Ltd
Welding Technology Institute of Australia

ASSOCIATE MEMBERS

A & S Engineering Ltd
A W Trinder Ltd
ABB Power Limited
Acrow Limited
Advanced Plasma Technology
Aimecs Ltd
Airwork (NZ) Ltd
All Steel Services Ltd
Alloy Yachts International Limited
ALRO Truck Smash Repairs
Alstom Northern Wagons
ANDAR-ADM Group Ltd
APV New Zealand Ltd
ATCO Controls Ltd
ATI Engineering Ltd
Awesome Awnings Ltd
Axiam Engineering Limited
Bailey Engineering Ltd
Baker Cranes Ltd
Bantrans Engineering Ltd
Bay of Plenty Polytechnic
BBC Technologies Ltd
Bedford Engineering Ltd
Best Bars Ltd
Bitumen Equipment Ltd
BOP Gear Cutters Ltd
Bradken Dunedin
Brightwater Engineers Ltd
C J Saunders Engineering Ltd
Calder Stewart Steel
Cambridge Welding Service (1953) Ltd
Campbell Tube Products Ltd
Canco Engineering Ltd
CAS Enterprises Ltd
CFM Engineering Ltd
Christian Church Community Trust
Clough Agriculture Ltd
Consolidated Engineering Company Ltd
Contract Connections Ltd
Cook Brothers Construction
Courtney Engineering
Croucher & Crowder Engineering Co Ltd
Culham Engineering Co
D R Howells Engineering Co Ltd
Dan Cosgrove Ltd
Dawn Group Ltd
Dimond
Domett Trailers
Donovan Group NZ Ltd
DSK Engineering Ltd
Eastbridge Ltd
Eastern Institute of Technology
Ede Engineering
Electropar
Engineering Contractors Ltd
Enterprize Steel
Eric Paton Ltd
Etech Industries NZ Ltd
Fairbrother Industries Ltd
Fairfax Industries Ltd
Farmex Hawkes Bay Ltd

Felix Research Labs
Flotech
Fraser Fire & Rescue
Fruehauf Limited
G T Liddell Contracting Ltd
Gamman Industrial Componentry Ltd
General Engineering North Shore
George Grant Engineering
Gisborne Development Incorporated
Gray Construction
Greymouth Petroleum
Harford Greenhouses
Hayes International
Honor Well-drillers Ltd
Howick Engineering Ltd
Hydraulink Fluid Connectors Ltd
Iain Codling Stainless Steel
Ipsco Ltd
J & D McLennan Ltd
J J Niven Engineering Ltd
J P Marshall & Co Ltd
Jay Cee Welding Ltd
Jetweld Engineering
Keith M J Adams
Kernohan Engineering Ltd
Kerry Dines Ltd
Kopu Engineering Ltd
Lakeland Steel Products Ltd
Laser Welding Ltd
Leonard Products Ltd
Linear Design
Longhore Engineering Ltd
Mace Engineering Ltd
Machine Part Welding Ltd
Maskell Productions Ltd
MB Century Ltd
McEwan Engineering
Mecal Ltd
Michael Harris (NZ) Ltd
Mike Christie Sheetmetals Ltd
Millers Mechanical (NZ) Ltd
Mobridge Ltd
Modern Transport Engineers Ltd
Mooloo Stockcrates Ltd
Morgan Engineering & Marine Ltd
Morgan O'Shea Engineering
Morrow Equipment Co (NZ)
Mouats Engineering Ltd
MSC Engineering
Mulcahy Engineering Ltd
Murray Landon
Napier Engineering & Contracting Ltd
NDA Group
Necklen Engineering Ltd
Nelson Reliance Eng Co Ltd
Nelson Stud Welding Ltd
Nepean Engineering Ltd
Niemac Industrial Ltd
Noble Engineering Services Ltd
NZMP Kauri
Otago Polytechnic

Otahuhu Engineering Ltd
Pacific Timber Engineering Ltd
Parr & Co Limited
Patchell Industries Ltd
Pearson Engineering Ltd
Peninsula Engineering Ltd
Phoenix Steel Ltd
Piako Transport Engineering
Pilcher Engineering Ltd
Port of Napier Ltd
Precision Turning & Manufacturing Ltd
Pyramid Engineering
Razos Engineering Ltd
Read Industrial Ltd
Red Steel Limited
Reel Stainless
Refrigeration Engineering Co Ltd
Renold New Zealand Ltd
Rex Barnes Engineering
RNZAF
Roadmaster Trailers Ltd
Rocktec Ltd
ROTIG Ltd
Ruakaka Engineering
Sensation Yachts Ltd
Service Engineers Ltd
Sharland Engineering
Ship Constructors Ltd
Snorkel Elevating Work Platforms
Soanes & Vision Engineering Ltd
South Auckland Forgings Engineering Ltd (SAFE)
Southern Cross Engineering Limited
Southern Equipment Centre
Specialised Container Services
Specialist Energy Engineering Developments (S.E.E.D)
Sta-Tec Manufacturing
Stafford Engineering Ltd
Stainless Down Under
Stainless Engineering Co Ltd
Steel Structures Ltd
Steelbro NZ Ltd
Steelfort Engineering Company Ltd
Steelpipe Limited
Stevensons Structural Engineers Ltd
Stewart & Cavalier Ltd
Street Marine Ltd
Stud Welding New Zealand Ltd
Superior Pak Ltd
Taslo Engineering
Tasman Engineering Company
Technical Welding Services (1998)
The 4711 Training Centre
The School of Welding
Tidd Ross Todd Ltd
Transfleet Equipment Ltd
Trident 2000 Ltd
Truweld Engineering Kerikeri Ltd
Ullrich Aluminium Co
Verissimo Engineering Ltd

W M Ross Engineering Ltd
Wainuiomata Training Centre
Waratah NZ Limited
Warner Construction Ltd
Webforge NZ
Weld Fabrication Engineering Ltd
Weld Tests Hawkes Bay
Welding Technology Ltd
Wells & Boe Ltd
Whangaparaoa Engineering
Whangarei Engineering Company Ltd
Wilson Bros Engineering Ltd
Wilson Precast Construction Ltd
Windflow Technology Ltd
Windsor Engineering
Wyma Engineering NZ Ltd
Zealsteel Ltd

ORDINARY CONSULTANTS

Abacus Engineering Ltd
ABB Maintenance Service Kinleith
ACH Consulting Limited
AECOM
Airey Consultants Ltd
Alan Reay Consultants Ltd
Allan Estcourt Ltd
Antro Enterprises Limited
Aurecon New Zealand Ltd
Babbage Consultants Ltd
Base Consulting Engineers Ltd
Batchelar McDougall Consulting Ltd
Beca Carter Hollings & Ferner Ltd
Belcher Industries Ltd
Bill Cassidy & Associates
Bloxam Burnett & Olliver Ltd
Blueprint Consulting Limited
BPL Group
Brian Carter Consulting Engineer Ltd
Brian Jones Engineering Ltd
Brown & Thomson
BSK Consulting Engineers Ltd
Buchanan & Fletcher Ltd
Buller George Turkington Ltd
C L C Consulting Group Ltd
Cameron Gibson & Wells Ltd
Chambers Consultants Ltd
Chapman Oulsnam Speirs Limited
Chapman Sanders Consultants
Charles Consulting
Chester Consultants Ltd
Chris W Howell & Associates Ltd
Civil Engineering Central Ltd
Clendon Burns & Park Ltd
Compusoft Engineering
Coulter Engineering Services Ltd
CPG New Zealand Ltd
David Smart Consulting Ltd
Davidson Group Ltd
Davis Ogilvie & Partners Ltd
Day Consultants
DBCon Ltd
Design Engineering (SI) Ltd
Design Management Consultants Limited
DezignWorks BOP
DHC Consulting Limited
Dick Joyce Consultants Ltd
Dobbie Engineers Ltd

Dodd Civil Consultants
Don Thomson Consulting Engineers Ltd
Dunning Thornton Consultants Ltd
Eastern Consulting Ltd
EMC-2
Engineered Cold Systems Ltd
Engineering Design Consultants Limited
ETS Engineers Ltd
Fairclough and King Consultants Ltd
Fletcher Construction - Engineering
Flo-Dry Engineering Ltd
Fraser Thomas Limited
Geoff Kell Consulting Ltd
GHD Ltd
Gray Consulting Engineers Ltd
Hadley & Robinson Ltd
Hanlon & Partners Ltd
Harrison Grierson Consultants Ltd
Hawthorn Geddes Engineers & Architects Ltd
HFC-Harris Foster Consultants Ltd
Hill Design Engineering Ltd
HLK Jacob Limited
Holmes Fire & Safety
Hugh Barnes Consultants Ltd
JAWA Structures Ltd
JNG Engineers Ltd
Kerslake & Partners
Kevin O'Connor & Associates Ltd
Kirk Roberts Consulting Engineers
Knowles Consulting
Kordia Ltd
Les Boulton & Associates Ltd
Lewis & Barrow Ltd
Lewis Bradford & Associates Ltd
LHT Design
Lough Downey Ltd
M.A. Corkery & Associates Ltd
Macdonald Barnett Partners Ltd
Manktelow Consulting Engineers Ltd
Marino Consultants & Associates
Markplan Consulting Ltd
Marriott Consulting Engineers
McDowall Structures
MEC Engineering Consultants
Mechanical Technology Ltd
Metal Test Ltd
Mighty River Power Limited
Milward Finlay Lobb Ltd
Mitchell Vranjes Consulting Engineers Ltd
Mobil Oil New Zealand Limited
MSC Consulting Group Ltd
MTEC Consultants Ltd
MWH New Zealand Ltd
Nagel Consultants Ltd
Norfolk Projects Ltd
Novare Design Ltd
O'Loughlin Taylor Spence Ltd
OCEL Consultants NZ Ltd
Optimech International Ltd
Opus International Consultants Ltd
Orica Powder & Industrial Coatings
Paul Gellatly Consulting Engineer
PB Parsons Brinckerhoff
Peter Walker Consultants Ltd
Peters and Cheung Ltd
PFP Systems (NZ) Ltd

Plant & Platform Consultants Ltd
Plumb Ltd
Pont Consultants
Powell Fenwick Consultants Ltd
Protocol Services Ltd
Q Designz Limited
R D Sullivan & Associates
R J Nelligan & Associates Ltd
R W & V Roberts Consultancy
Randall & Associates Ltd
RCR Energy Systems Ltd
Redco NZ Ltd
Richardson Stevens Consultants (1996) Ltd
Ruamoko Solutions Ltd
Sawrey Consulting Engineers Ltd
Sigma Consultants Ltd
Silvester Clark Consulting Engineers
Sinclair Knight Merz (SKM)
Spencer Holmes Ltd
Stephen R Mitchell Consulting
Stiffe Hooker Ltd
Stiles & Hooker Ltd
Strata Group Consulting Engineers Ltd
Structex Limited
Structural Concepts Ltd
Structure Smith Ltd
Structured Solutions Ltd
Tangaroa Energy Rakaia Amps Ltd
Tenix
TH Consultants Ltd
Thorburn Consultants (NZ) Ltd
Thorne Dwyer Structures
Tonkin & Taylor
Transfield Worley Ltd
Transport Design & Certification
Transport Technology Ltd
Transtech Dynamics Ltd
Tse Taranaki & Associates Limited
TSV Consulting
URS New Zealand Ltd
Verstoep & Taylor Ltd
W Stringer Consulting
Waikato Engineering Design Ltd
WH NF Johnston Ltd
Wilkinson Transport Engineers

ORDINARY FABRICATORS

A & G Price
Acme Engineering Ltd
Active Engineering Solutions Ltd
Active Welding Limited
Advance Boiler Services NZ Ltd
Allied Industrial Engineering Ltd
Amtec Engineering Ltd
Atco Steel Developments Ltd
Babcock Fitzroy Ltd
BDC Engineering
BLM Engineering Co Ltd
Boden Pipe Ltd
Bromley Steel
Bucher-Alimentech Ltd
Burleigh Engineering Ltd
Chapman Engineering Ltd
Combustion Control Ltd
Consortium Engineering Services
Crusader Engineering Ltd

CSP Pacific
Cylinder Testing NZ
D C Weld Ltd
D&H Steel Construction Limited
Dexion New Zealand
Dispatch and Garlick Ltd
E B McDonald Ltd
East Coast Steelwork Ltd
Eastland Engineering 2004 Ltd
Energyworks Ltd
Equipment Engineering Ltd
Ewing Construction Ltd
Farra Engineering Limited
Fitzroy Engineering Group Ltd
Gary Douglas Engineers Ltd
Gisborne Engineering Ltd
Gray Bros Engineering
Grayson Engineering Ltd
Haden & Custance Ltd
Hornell Industries Ltd
HSM Engineering Ltd
Intergrated Maintenance Group Limited (IMG Ltd)
J & R Slecht Limited
J Steel Australasia Pty Ltd
Jensen Steel Fabricators Ltd
John Jones Steel Ltd
Juken New Zealand Ltd (Wairarapa)
Kawerau Engineering Ltd
KiwiRail Limited
Kraft Engineering Ltd
Lytelton Engineering Ltd
M J H Engineering Ltd
Mainarc Engineering Services Ltd
Martin Engineering
MaxiTRANS Industries (NZ) Pty Ltd
McGrath Industries Limited
McKenzie & Ridley (Kawerau) Ltd
McLaren Stainless Ltd
Mercer Stainless Ltd
Metso New Zealand Limited
MGE Engineering Ltd
Modern Construction Ltd
Morgan Steel
New Zealand Steel Ltd
NZ Army-Trade Training School
Oceania Aviation Ltd
Otahuhu Welding Ltd
P J Hindin Engineering
Page & Macrae Limited
Pakuranga Engineering Ltd
Patton Engineering Ltd
Pegasus Industrial Engineering Ltd
PFS Engineering Ltd
Powerhouse Forestry Ltd
Pro Steel Engineering Ltd
RCR Energy Systems Ltd
RNZN Operational Support Group
Roadrunner Manufacturing (NZ) Ltd
Robert Page Engineering Ltd
Sabre Engineering
South Pacific Industrial
Southern Spars Limited
Speedfloor NZ
Steltech Structural Limited
Stevenson Engineering Ltd
Tanker Engineering Specialists Ltd

TATA Steel International (Australasia) Ltd
Taymac Limited
Texco Steel Ltd
Tidal Power NZ Ltd
Track Industries Ltd
Tranzweld
Traydec (NZ) Ltd
Turnco Engineering Limited
United Engineering Services Ltd
Universal Engineering Ltd
Waikato Steel Fabricators Ltd
Weld IT Ltd
Weldtrade Engineering Ltd
Weldwell New Zealand
Whakatiki Engineering (1984) Ltd

ORDINARY PRODUCT SUPPLIERS

Air Liquide New Zealand Ltd
Akzo Nobel Coatings Ltd
Altex Coatings Ltd
Ballance Agri-Nutrients Ltd
BOC Gases New Zealand Ltd
Combustion Control Ltd
Crow Refractory Ltd
Denis Cunningham Ltd
Digitalweld
Eastland Engineering 2004 Ltd
Forman Building Systems Ltd
H J Asmuss & Co Ltd
Independent Oilfield Inspection Services Ltd
Independent Technology Ltd
Lincoln Electric Co (NZ) Ltd
Mainzeal Property & Construction Ltd
Modern Maintenance Products Ltd
New Zealand Steel Ltd
Onesteel NZ Limited
Pacific Steel
Piletech NZ Ltd
Pipes NZ Limited
PPT
Sandvik New Zealand Ltd
TATA Steel International (Australasia) Ltd
Traydec (NZ) Ltd
Trustpower Ltd
Wattyl (NZ) Ltd
Welding Engineers NZ Ltd
Weldtrade Engineering Ltd
Weldwell New Zealand

ORDINARY SERVICES PROVIDERS

Advanced Training Academy
Alpha Training & Development Centre Ltd
Altex Coatings Ltd
Aoraki Polytechnic
Auckland Council
Auckland University of Technology (AUT)
Bay of Plenty Energy Ltd
BDS VIRCON
Bureau Veritas (NZ) Ltd
CADPRO Systems Ltd
Christchurch Polytechnic Institute of Technology (CPIT)
Contact Energy

CSP Coating Systems (aka) CSP Galvanizing
EverEdge IP Limited
Forman Building Systems Ltd
Forman Insulation Limited
Hawkins Construction Ltd
Independent Oilfield Inspection Services Ltd
Manukau Institute of Technology
Marine Consultancy NZ
Materials & Testing Laboratories
Matrix Applied Computing Ltd
Meridian Energy Ltd
Metal Tech Education Ltd
Metal Test Ltd
Motovated Design and Analysis Ltd
New Zealand Refining Co Ltd
New Zealand Transport Agency
NZ Army-Trade Training School
NZ Welding School
Port of Tauranga Limited
Robert Page Engineering Ltd
SGS New Zealand Limited
Southern Institute of Technology
Southern QA Ltd
Spencer Holmes Ltd
Steel Drafting Ltd
Stork Cooperheat New Zealand Ltd
Structurflex Limited
Techlogic NZ
Technical Support Services DOL
Tenix
UCOL
Unitec Applied Technology Institute
University of Auckland (UoA)
Victoria University of Wellington
Waikato Institute of Technology (WINTEC)
Weatherford New Zealand
Weldwell New Zealand
Wellington Institute of Technology
X-Ray Laboratories Ltd

RECIPROCAL MEMBERS

American Institute of Steel Construction (AISC)
American Welding Society (AWS)
Australasian Corrosion Association (ACA)
Australian Steel Institute (ASI)
Bio Energy Association of New Zealand (BANZ)
British Constructional Steelwork Association (BCSA)
Canadian Institute of Steel Construction Competenz
DVS - German Welding Society
National Association of Steel Framed Housing (NASH)
National Library of New Zealand**
NZ Institute of Economic Research
Power Crane Association of NZ (Inc)
Steel Construction Institute (SCI)
Steel Construction New Zealand (SCNZ)
Waikato Engineering Careers Association (WECA)



HERA STRUCTURE

The Association is based at HERA House in Manukau City. Within HERA House are the offices of HERA and associated organisations such as Metals NZ, NASH, SCNZ, and a conference facility which can cater for up to 120 participants.

Through its specialist staff it provides a combination of research, training, advisory, industry development and promotional services making it the national centre for metals-based product design, manufacturing technology and inspection and quality assurance. HERA is an accredited training provider under NZQA and the International Institute of Welding (IIW) guidelines.

HERA also performs industry advocacy functions developing HERA member policy on items relating to R&D and heavy

engineering industry development and communicates this to government and other relevant bodies.

Research is selected on the advice of subject specific industry advisory panels and is usually of applied nature with short- to medium-term implementation. HERA's research activities encompass the areas of steel construction, general heavy engineering including welding/joining, clean energy technology, industry capability and marketing.

HERA incorporates the activities of the Heavy Engineering Industry Development Division, Structural Systems Division, New Zealand Welding Centre, Inspection & Quality Control Centre, and its Information Centre with the following specific services and activities:

Structural Systems Division

- Through Steel Research Panel sets priorities for NZ steel and composite construction R&D
- Applied research supporting the use of steel and composite elements and systems
- Input into New Zealand's performance-based *Building Control System*
- Technology transfer mainly in the form of advice, training, consultation and including Finite Element Analysis.

Heavy Engineering Industry Development Division

- Maintains and promotes capabilities of the membership
- Provides advice on international, tariff and marketing issues of significance to the metals industry

- Performs targeted business development initiatives for the heavy engineering sector

New Zealand Welding Centre

- Specialised welding and joining research including technology transfer to industry of new processes and techniques
- Welding consultation including practical welding advice
- Educational courses and seminars, including training leading to NZQA and International Institute of Welding (IIW) qualifications
- Providing input into national and international welding related standards
- Provision of educational material for welding-related training

I&QC Centre

- Courses covering welding inspection and NDT inspection methods
- Elevated work platform, and pressure vessel inspection courses
- Inspection-related seminars such as Management Appreciation in Quality Control and Inspection

HERA Information Centre

- Library with over 11,000 entries and 180 periodicals with specific relevance to the metals industry of NZ
- Distribution of HERA publications and publications for a number of New Zealand and overseas organisations
- Membership Management, marketing and servicing

HERA STAFF 2011

Administration

Director Dr Wolfgang Scholz
Accounts Officer Kam Subramani

HERA Information Centre (HIC)

Manager Brian Low
Resources Officer Gillian Casidy
Receptionist Raewyn Porter

Heavy Engineering Industry Development

Manager Nick Inskip

Inspection & Quality Control Centre (I & QC Centre)

Manager Peter Hayward

Structural Systems

Manager Dr Stephen Hicks
Finite Element Analyst Nandor Mago
Structural Engineer Audsley Jones

New Zealand Welding Centre

Manager Dr Michail Karpenko
Senior Welding Engineer Alan McClintock



Standing, from left: Alan McClintock, Holger Heinzl, Gael Pouzadoux, Gillian Casidy, Raewyn Porter, Audsley Jones, Kam Subramani, Nandor Mago
Sitting, from left: Brian Low, Dr Michail Karpenko, Nick Inskip, Dr Wolfgang Scholz, Dr Stephen Hicks, Peter Hayward

HERA

Innovation in Metals



HERA House, 17-19 Gladding Place

PO Box 76-134, Manukau City

New Zealand

Phone + 64 9 262 2885

Fax +64 9 262 2856

email admin@hera.org.nz

website www.hera.org.nz

